



# STAND-ALONE PROXIMITY ACCESS CONTROL SYSTEM

# **Company Profile**

---

Centurion Systems (Pty) Ltd, South Africa, has been manufacturing automatic gate systems since 1986, and is committed to providing reliable, cost effective solutions in the field of gate and access automation.

We offer a diverse range of products including gate motors, GSM-based products, garage door motors, remote controls, keypads, traffic barriers, proximity access control and intercom systems.

Our products are developed by an in-house team of talented engineers that are constantly researching new and innovative technologies to improve our existing products and expand our product range.

Our production facility in Johannesburg is ISO:9001 quality assurance certified, and all our products are manufactured to the highest level of quality with a 100% test to specification.

Through a team of dedicated technicians and sales personnel, together with a fully fledged in-house training facility, we are committed to providing unmatched service to our customers and support for our products.

A worldwide network of distributors and installers ensure that our products remain The Automatic Choice in access automation .

Further information is available on our website [www.centsys.com](http://www.centsys.com)



Centurion Systems (Pty) Ltd reserves the right to make changes to the products described in this document without notice and without obligation of Centurion Systems (Pty) Ltd to notify any persons of any such revisions or changes. Additionally, Centurion Systems (Pty) Ltd makes no representations or warranties with respect to this document.

No part of this document may be copied, stored in a retrieval system or transmitted in any form or by any means electronic, mechanical, optical or photographic, without the express prior written consent of Centurion Systems (Pty) Ltd.

# Table of Contents

---

Product Overview .....	5
Specifications .....	6
Tools and Equipment Required .....	7
<b>QUIK Installation</b>	
QUIK WIRING DIAGRAM .....	8
QUIK ADD: New Installation .....	9
QUIK ADD: Existing Installation .....	10
QUIK DELETE .....	11
QUIK PARAMETER FACTORY DEFAULT .....	12
Installation of <b>SOLO</b> Reader .....	13
Wiring Diagrams .....	16
Overview of User Interface .....	20
Identification of Tags .....	20
Find Master Tags .....	21
Find User Tag Memory Location .....	22
Example: How to find User Tag Memory Location .....	23
<b>HOW TO ADD A TAG</b>	
Overview .....	24
ADD Tag: <b>SOLO</b> Specified Memory Location .....	25
Example: How to use the LED's to select Memory Locations .....	27
ADD Tag: User Specified Memory Location .....	28
<b>HOW TO DELETE A TAG</b>	
Overview .....	31
DELETE Tag: Tag not available .....	32
Example: How to use the LED's to select Memory Locations .....	34
DELETE Tag: Tag available .....	35
REPLACE a Secondary Master Tag (Tag in Memory Location 01) .....	37
REPLACE a Primary Master Tag (Tag in Memory Location 00) .....	39
COMPLETE DELETE: Restore Factory Defaults and Clear Memory .....	41

---

## HOW TO CONFIGURE THE DIFFERENT OPERATING PARAMETERS

Overview .....	43
Turning the TAG BUZZER on or off .....	45
Turning the FREE EXIT on or off .....	47
Turning the DOOR FORCED ALARM OUTPUT on or off .....	49
Turning the DOOR FORCED ALARM LOCAL BUZZER on or off .....	51
Turning the DOOR OPEN ALARM OUTPUT on or off .....	53
Turning the DOOR OPEN ALARM LOCAL BUZZER on or off .....	56
Turning the SMARTSWITCH II on or off .....	59

## HOW TO SET VARIOUS TIMERS

Overview .....	62
Example: How to use the LED's to set the various Timers .....	64
Change Relay Time .....	65
Change Door Open Time .....	68
Change Door Open Pre-Warn Time .....	71
Change Door Open Alarm Time .....	74
Change Door Forced Alarm Time .....	77
Change Hold Off Time .....	81

## SPECIAL FUNCTIONS

Turbo Mode .....	85
Autolearn Overview .....	86
Autolearn: LIMITED TIME .....	87
Autolearn: UNLIMITED TIME .....	88
Autolearn: DISABLE .....	89

MEMORY ALLOCATION AND PARAMETER SETTINGS FORM .....	90
---	----

ADVANCED USER MAP .....	can be found between 46 & 47
SURFACE MOUNT DRILLING TEMPLATE .....	can be found between 46 & 47

# Product Overview

---

The **SOLO** is a cost effective entry level stand-alone proximity access control system for single access point applications. By presenting a valid CENTSYS proximity tag to the **SOLO** Reader it will activate or release the access point door lock or operator and allow access.

The **SOLO** Reader is a robust weatherproof unit that is mounted adjacent to the door or access point. It is a fully integrated unit with the controller, read coil and output drives all contained inside the unit.

The **SOLO** model 50 can store up to 51 unique proximity Tags of which two are Master Tags. Tags are stored on the units non-volatile memory in separate Memory Locations. The use of Memory Locations allows for selective addition and deletion of Tags as required.

Programming of the system is done using either of the Master Tags and the indicator lights on the front of the Reader. To further simplify the installation of the **SOLO** Reader all parameters are pre-programmed according to most application requirements.

Both audible and visual feedback is provided if a valid Tag is presented. In addition, visual feedback is given if the presented Tag is invalid.

The **SOLO's** single output channel provides a potential free Normally-Open or Normally-Closed contact and can be configured as latching or pulsed. The pulsed time is adjustable in one second increments from one second to four minutes.

The output can also be configured to operate with a CENTSYS SMARTSWITCH II.

The Smartswitch II is mounted directly at the door lock or gate motor to provide an even higher level of security by preventing a would-be intruder from tampering with the door lock/gate trigger lines to gain entry.

The **SOLO** provides a free-exit facility. This is typically where a pushbutton mounted on the inside of the door or gate entrance is required to operate the access point. For added security, this feature can be inhibited if not being used.

The **SOLO** provides an input for door/gate sensor that can be used to detect whether the access point has been forced open or left open. The unit in turn provides an open collector output with pulse or latching facility so that either or both of these alarm conditions can be relayed to a "third party" alarm system.

In addition an optional tamper alert switch is available that can be connected to a "third party" alarm to provide an early warning if the **SOLO** Reader is being forced open.

The access point left open alarm will only activate after the pre-warn time (internal buzzer) followed by the access point left open time have expired. The pre-warn and access point left open times are programmable in one second increments from one second to four minutes.

Mounting of the **SOLO** is very simple as it can be flush mounted into a 100mm x 50mm light switch box or surface mounted directly onto the wall. In addition, the unit can be purchased with an anti-knock shield, providing better protection when surface mounting the unit externally or to a gooseneck.

# Specifications

<b>Physical</b>	
Supply Voltage	10 - 12V AC 12-15V DC
Standby Current	50mA
Maximum Current	180mA
Operating Temperature	-20°C to 50°C
Operating Humidity	0-90% non condensing
Tag Frequency	13.56 MHz
Housing Material	ABS UV Stabilised
Degree of Protection	IP 55
Dimensions	
Surface Mount	129H x 90W x 29D
Flush Mount	125H x 85W x 16D
<b>Outputs/Inputs</b>	
Output channel	Single output selectable as relay (NC or NO) or open collector
Relay rating	50V @ 3A non inductive (N/C, COM, N/O)
Open collector rating (CHD)	Maximum 50mA (positive connected to CHD+)
Door open/forced output (ALARM)	Maximum 50mA (positive connected to CHD+)
SmartSwitch II power output	Maximum 200mA (CHD+)
Free exit input	Potential free normally-open contact (FRX)
Door sense input	Potential free normally-closed contact (DOOR SEN)
Anti-tamper switch	Potential free normally-closed contact (Optional extra)
<b>Operational</b>	
Tag capacity	51 tags including Master/Admin
Tag read range	80 - 100mm
Output relay pulse time (s)	0 - 254 Adjustable in 1 second increments or Latch
Door open alarm delay time (s)	0 - 254 Adjustable in 1 second increments or Infinite
Door open pre-warn delay time (s)	0 - 254 Adjustable in 1 second increments or Infinite
Local Buzzer activation time (s) door open alarm	0 - 254 Adjustable in 1 second increments or Infinite
Hold off time (s)	0 - 255 Adjustable in 1 second increments

# Tools and Equipment Required

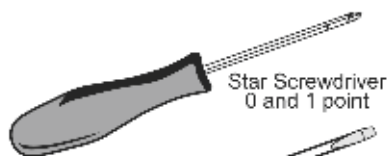

Star Screwdriver  
0 and 1 point

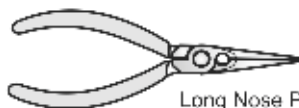

Long Nose Pliers

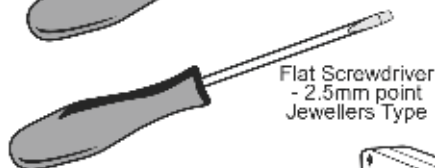

Flat Screwdriver  
- 2.5mm point  
Jewellers Type

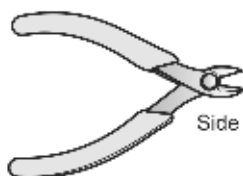

Side Cutters



Level

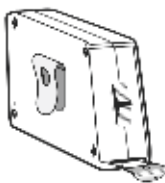

Tape Measure



Silicon

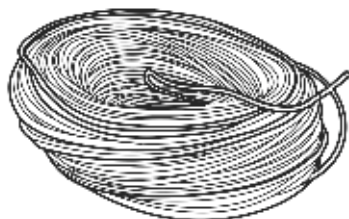

Cable: 0.20mm<sup>2</sup>  
0.50mm<sup>2</sup>  
0.75mm<sup>2</sup>

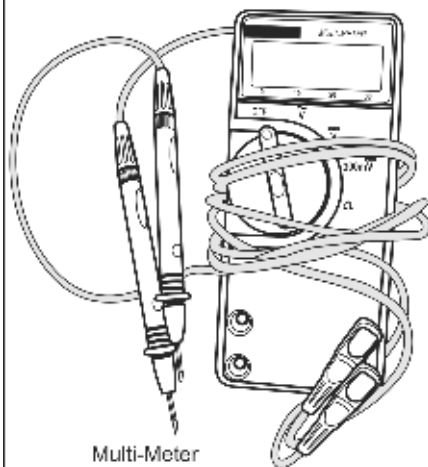

Multi-Meter



5mm  
Masonry Bit

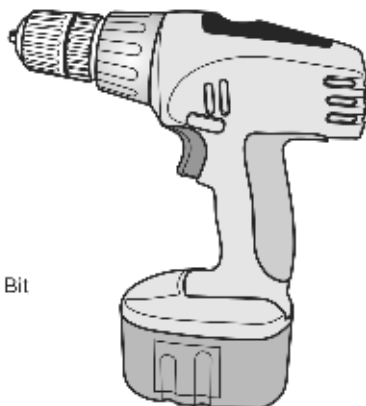

Drilling Machine  
(hammer action)

# Quik Wiring Diagram

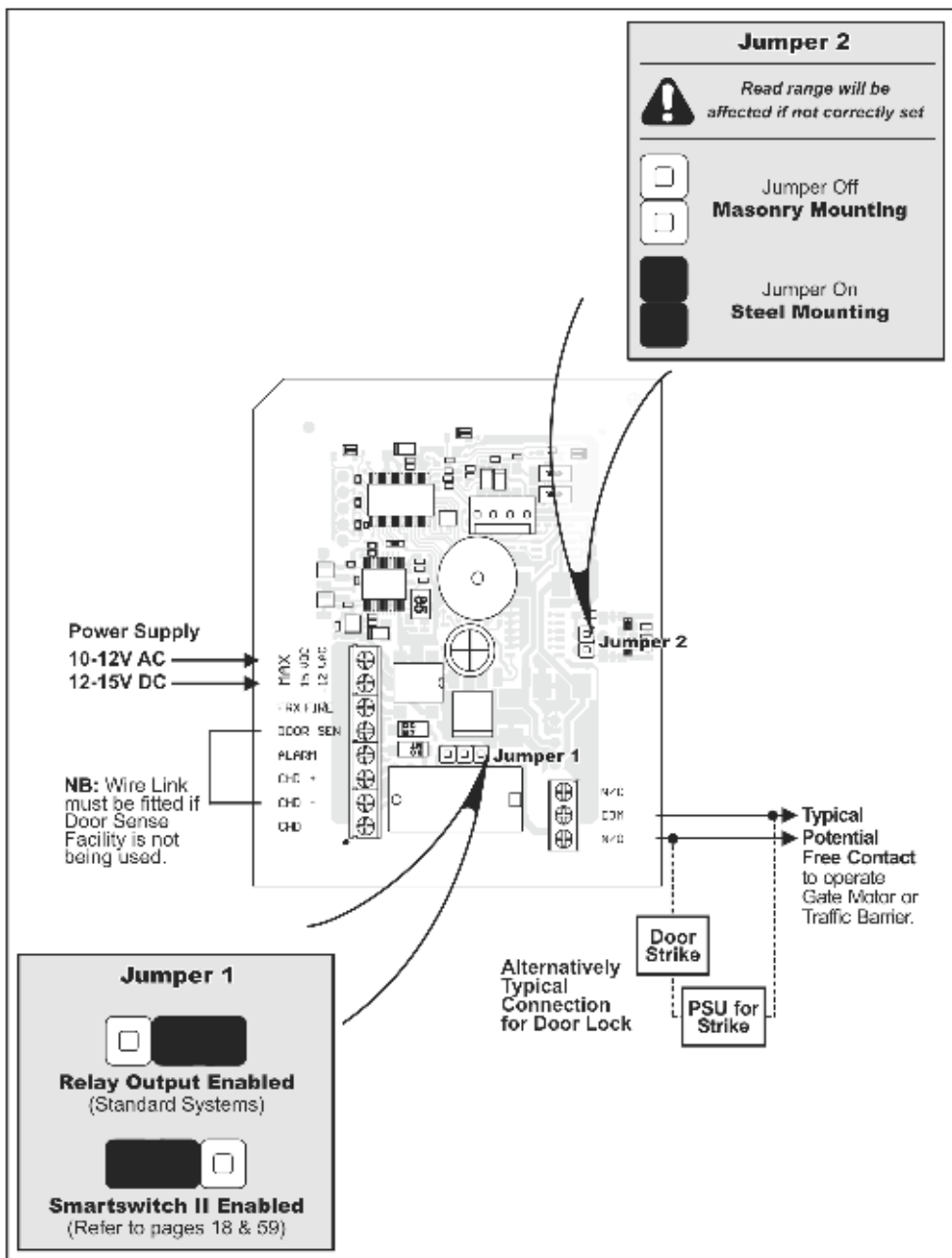

Fig 1. Quik Wiring Diagram



# Quik Add - New Installation

## Please Note:

- On power up the **TOP ROW LIGHTS** appear to chase each other. This indicates a Blank Memory.
- Tags will be added to the **SOLO** Reader sequentially from Memory Locations 00 to 50.
- The first two Tags presented to the **SOLO** Reader will become the Master Tags in Memory Locations 00 and 01.
- It is recommended that the first Master Tag be kept in a safe and secure location.
- The Master Tags should only be issued to those responsible for maintaining the **SOLO** Reader.
- To ABORT wait for ± 60 seconds for the SOLO to RESET**



Graphical Instructions		Written Instructions
1	<b>Power On</b>	Connect power to Reader
2	Observe Top Lights	<b>TOP ROW LIGHTS</b> flash in sequence
3		<b>Present and REMOVE</b> each New Tag to the <b>SOLO</b> Reader
4		<b>TOP GREEN LIGHT</b> will flash <b>BUZZER</b> will sound to indicate a successful addition
5		<b>Repeat from step 3</b> as required
6		<b>Present and REMOVE</b> the Master Tag

The **SOLO** Reader will enter normal RUN MODE

It is recommended that the attached Memory Location allocation and Parameter settings form be updated.

# Quik Add - Existing Installation

## Please Note:

- Tags will be added sequentially to the empty Memory Locations of the **SOLO** Reader. Previous Memory Locations will not be overwritten.
- To ABORT wait for ± 60 seconds for the SOLO to RESET**



Graphical Instructions		Written Instructions
1	Observe Lights	<b>Present and HOLD</b> either Master Tag until <b>all lights turn ON</b>
2		<b>Remove</b> the Master Tag
3	Observe Top Lights	<b>Top green light will remain on</b>
4		<b>Present and remove</b> each new Tag to the SOLO Reader
5		<b>TOP GREEN LIGHT</b> will flash and the <b>BUZZER</b> will sound to indicate a successful addition.
6		<b>Repeat from step 3</b> as required
7		<b>Present and REMOVE</b> the Master Tag

The **SOLO** Reader will enter normal RUN MODE

It is recommended that the attached Memory Location allocation and Parameter settings form be updated.

# Quik Delete - All Tags

## Please Note:

- This option will remove all Tags from the **SOLO** Reader's memory but will not change any of the Configuration Settings or Timer Values.
- To **ABORT** wait for  $\pm 60$  seconds for the **SOLO** to **RESET**

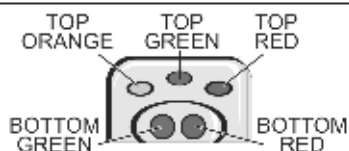

Present & Hold Master Tag



Remove Master Tag



Present & Remove Master Tag

## Graphical Instructions

## Written Instructions

1	Observe Lights		<b>Present and HOLD</b> either Master Tag until all lights turn ON
2			<b>Remove</b> the Master Tag
3	Observe Top Lights		<b>Top green light</b> will remain on
4	Observe Bottom Lights		Only <b>BOTTOM RED LIGHT ON</b> <b>Present and remove</b> the Master Tag
5			<b>Top red light</b> will turn on
6			Only <b>BOTTOM GREEN LIGHT ON</b> <b>Present and HOLD</b> the Master Tag
7			Continue <b>HOLDING</b> All the <b>LIGHTS</b> will begin to flash Continue <b>HOLDING</b>
8			Continue <b>HOLDING</b> Wait for the buzzer to bleep three times
9			Remove the Master Tag
10			The <b>TOP ROW LIGHTS</b> appear to chase each other, this indicates a Blank Memory.







It is recommended that the attached Memory Location allocation and Parameter settings form be updated.

## Quik Parameter - Factory Default

### Please Note:

- All Configuration Settings and Timer Values will be defaulted to factory settings.
- No Tags will be remove from the **SOLO** Reader memory.
- **To ABORT wait for ± 60 seconds for the SOLO to RESET**



Graphical Instructions		Written Instructions	
1	Observe Lights   	<b>Present and HOLD</b> either Master Tag until <b>all lights turn ON</b>	
2	Observe Top Lights   	Continue <b>HOLDING</b> Until <b>ONLY the TOP RED LIGHT</b> turns ON	
3		Remove the Master Tag	

The **SOLO** Reader will enter normal RUN MODE

It is recommended that the attached Memory Location allocation and Parameter settings form be updated.

# Installation of the Solo

## Positioning the Reader

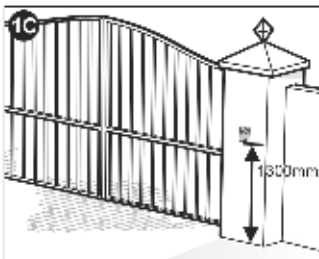
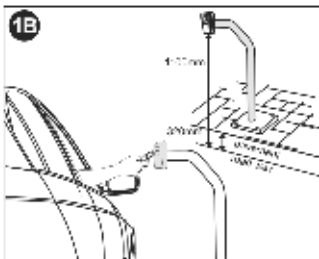
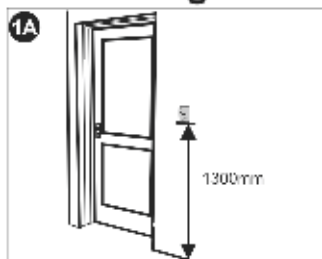

- Position **SOLO** reader on wall adjacent to door. Mount at a height that allows for the comfortable presenting of access tags. A height of 1300mm is recommended.
- Alternatively mount the Solo reader onto a gooseneck ensuring that:
  - The reader does not protrude too far into the driveway
  - The reader is not set too far back and cannot easily be accessed from a vehicle.
  - The height allows for the presenting of the tag to be comfortable from a vehicle.An anti-knock shield is available from CENTSYS to provide extra protection to the **SOLO** reader.
- Position the **SOLO** reader on wall adjacent to entrance gate. Mount at a height that allows for the comfortable presentation of access tags. A height of 1300mm is recommended.

## Mounting the Reader

The **SOLO** Prox reader is available in a flush mount kit and a surface mount kit.

When flush mounting, the reader adapts directly to a standard 100mm x 50mm (4" x 2") light switch backing box which allows the unit to sit flat against the wall.

Alternatively, if no backing box has been provided the unit can be very simply surface mounted.

When mounting the reader onto a gooseneck with, or without, an anti-knock shield, the surface mount kit will be used.

## Flush Mount

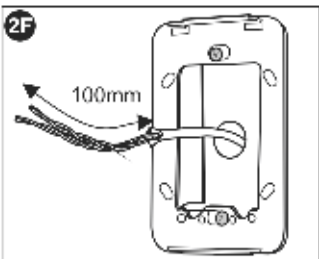
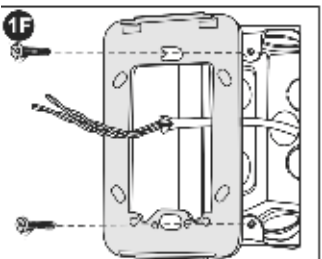

- Insert the reader mounting frame into position in the backing box and secure using the standard fixing screws provided with the backing box.
- It is recommended that the cabling to the reader extends at least 100mm through the frame.

## Surface Mount

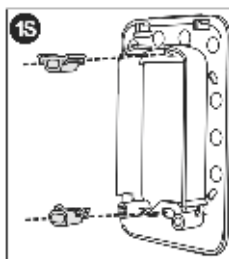

- Clip the plastic spacers onto the back of the mounting frame ensuring that they are correctly orientated to align with the mounting holes.

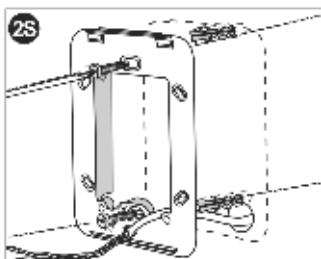

- Place the mounting template located in the centre of this document at the required height ensuring that it is vertical
- Using a 5mm masonry bit, drill holes into the wall for the rawplugs provided in the kit.
- Screw the frame lightly into position.

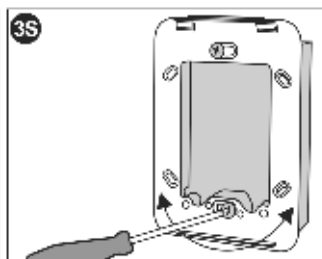

- Using the slots provided in the mounting holes, adjust the reader base to be perfectly vertical.
- Screw the frame firmly into position.

## Installation of the Reader (Flush or Surface Mount)

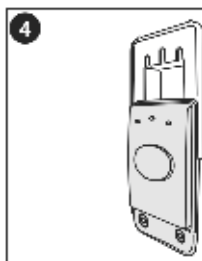

- Slide apart the front and back of the reader controller housing.

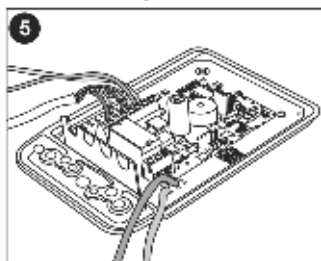

- Make the necessary terminations onto the controller. Refer to wiring diagram on page 16.

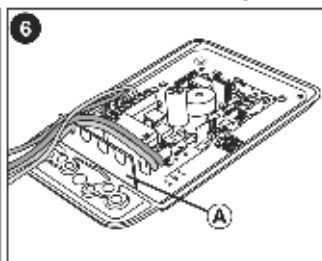

- Route the cable over the cable entry bulkhead (A) in the housing. Additional slots can be cut out to accommodate further cables if necessary.

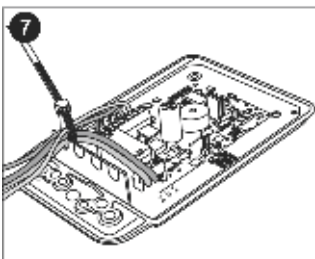

- Fit a cable tie around the cable as shown. When tightened this holds the cable in position and prevents it from being pulled out of the housing.

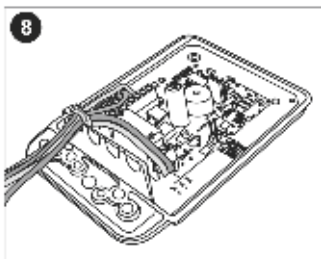

- Tighten cable tie.

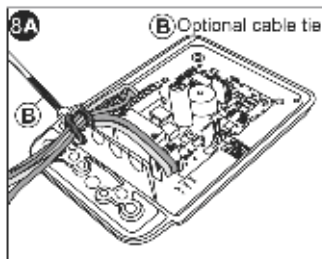

- An additional cable-tie can be fitted to better secure the cable.

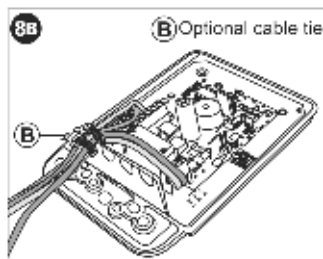

- If the additional cable tie was used, make certain that it is also tightened.

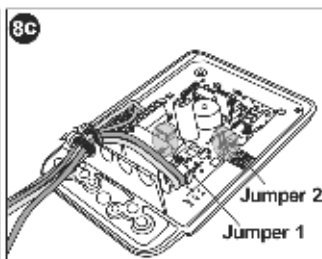

- Ensure Jumpers 1 and 2 are correctly positioned - refer to page 13.

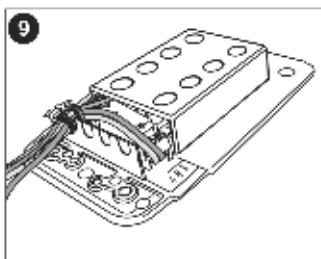

- Slide the back cover onto the controller housing.

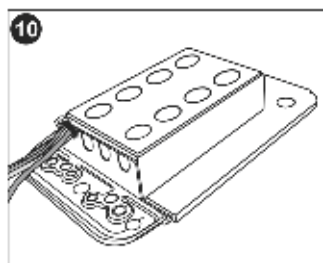

- Ensure that it sits neatly against the cable entry bulkhead securing the cable. To prevent insect ingress use either a grommet or a dab of silicon to seal the cable entry point.

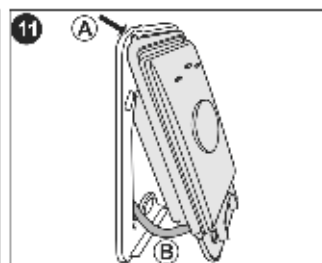

- Clip the top of the controller front housing into the top lip of the mounting frame (A), and fold down into position ensuring the cable is not caught (B).

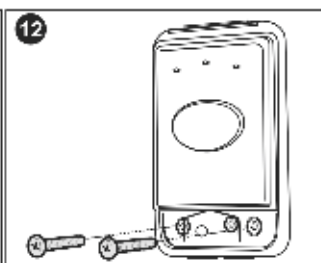

- Fasten controller housing into position using the 2 x M4 PT screws provided in the kit.

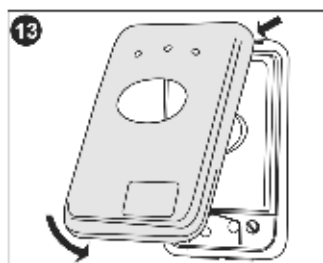

- Clip the outer cover into position making sure that it seats correctly and is secure.

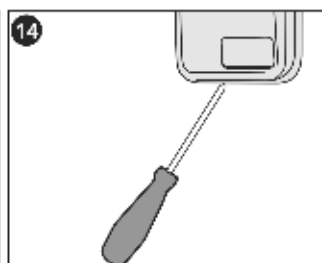

- To remove the outer cover, carefully insert a screwdriver between the cover and the wall from the underneath and unclip.

# Wiring Diagrams

## Identification of Terminals

The following figure shows the location of the terminal block on the **SOLO** controller, as well the position of Jumper 1 and Jumper 2. Refer to page 19 for an explanation of these jumpers. The table below details each terminal. In addition wiring diagrams have been provided showing how to connect all configurations of components to the **SOLO** system.

Details of Terminals		
Terminal	Cabling	Description
MAX 15 VDC 12 VDC	0.5mm <sup>2</sup>	Supply to the <b>SOLO</b> reader can be AC or DC, Min 12V DC or 10V AC. Input is not polarity sensitive.
FRX-FIRE	0.2mm <sup>2</sup>	Free-Exit, normally-open contact. Common connected to CHD-
DOOR SEN	0.2mm <sup>2</sup>	Input to indicate door/access point forced or left open. Normally-open contact. Common connected to CHD-
ALARM	0.2mm <sup>2</sup>	External alarm output (open collector)
CHD +	0.2mm <sup>2</sup>	SmartSwitch II or remote relay - Positive (+V)
CHD -	0.2mm <sup>2</sup>	SmartSwitch II or remote relay - Negative (-V)
CHD	0.2mm <sup>2</sup>	SmartSwitch II or remote relay - Control Signal selected by Jumper 1 in position 1
N/C COM N/O	0.75mm <sup>2</sup>	Potential free output relay for door release/access point trigger selected by Jumper 1 in position 2

Table 1. Details of Terminals

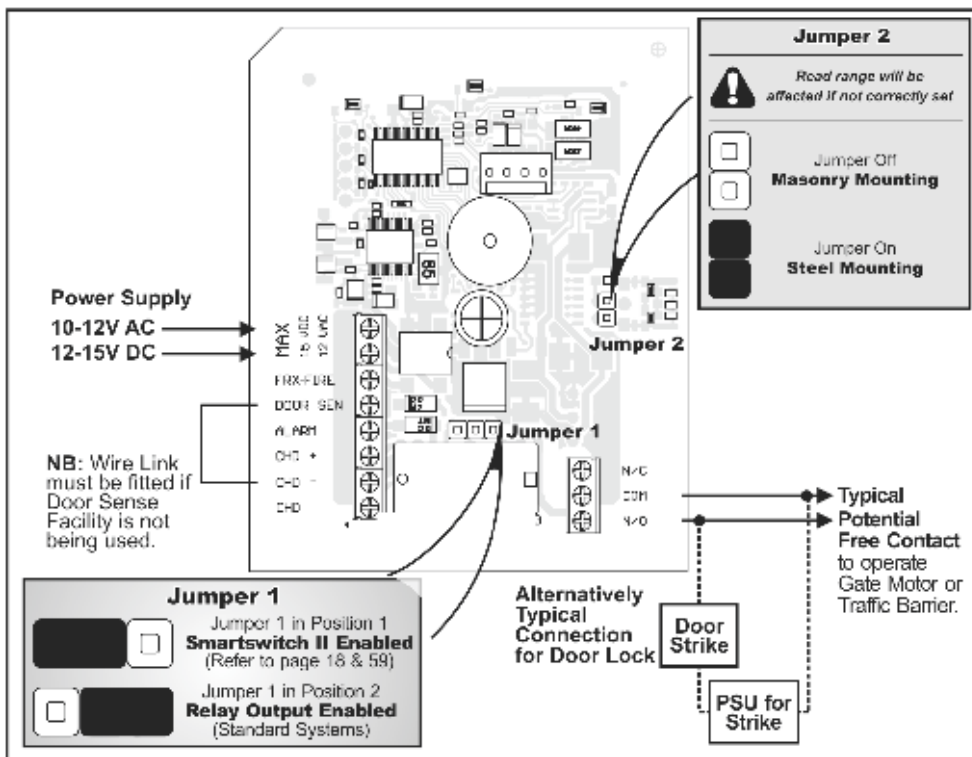

Fig 2. Identification of Terminals and Jumper Positions



### Solenoid - Electric Door Lock

Wire power to lock separately from the reader

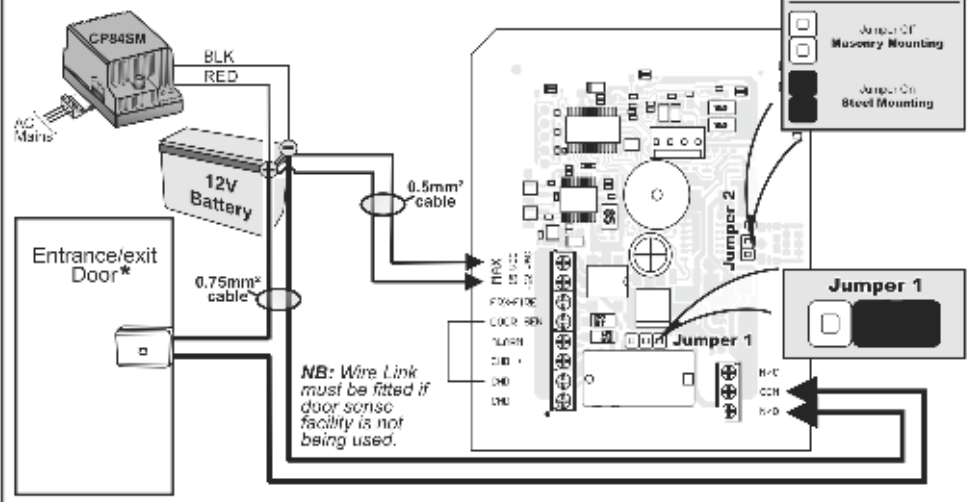

Fig 3. Wiring Diagram for Door Lock Type 1

### Mag-Lock; Magnetic Door Lock

Wire power to lock separately from the reader

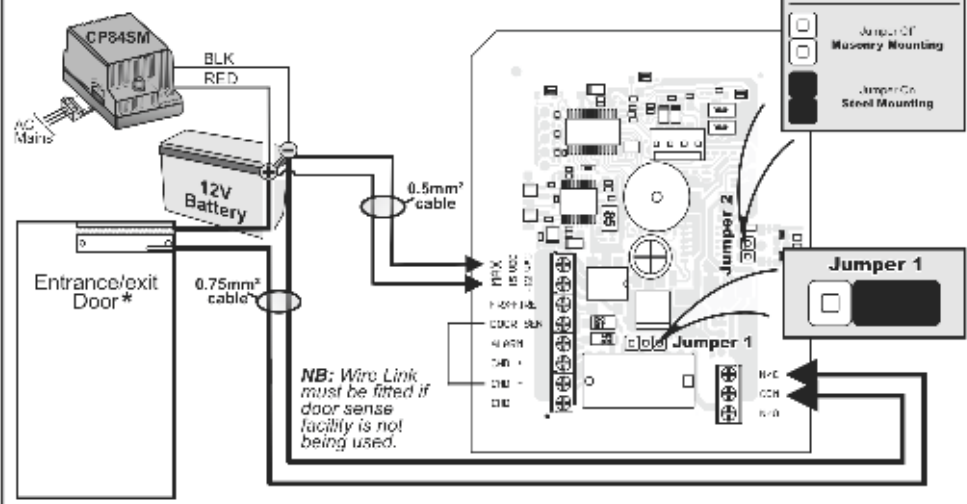

Fig 4. Wiring Diagram for Door Lock Type 2

**NB:** All types of locks can be interfaced via SmartSwitch II for anti-tampering security.  
**NB: \*** Fit appropriate emergency/fire exit measures where applicable.

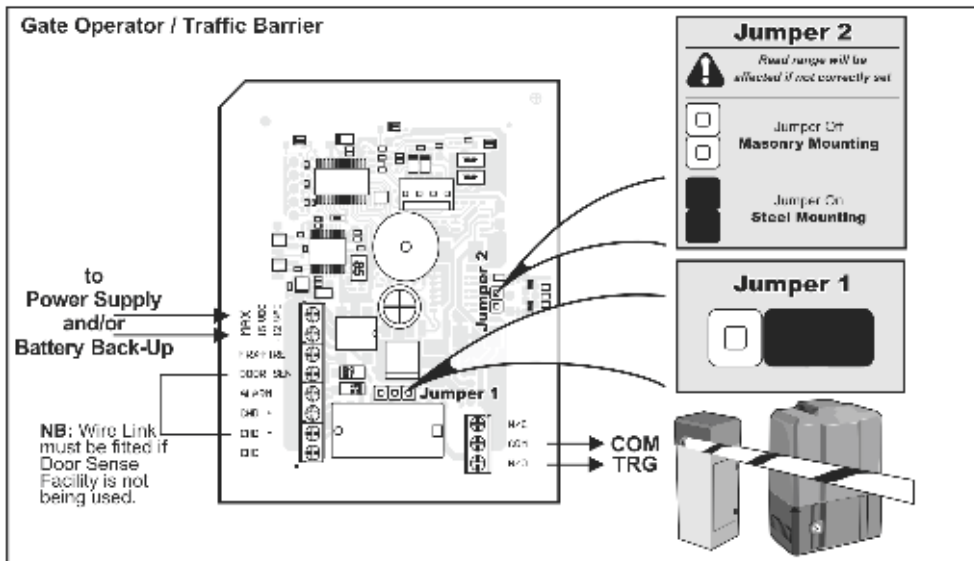

Fig 5. Gate Operator/ Traffic Barrier

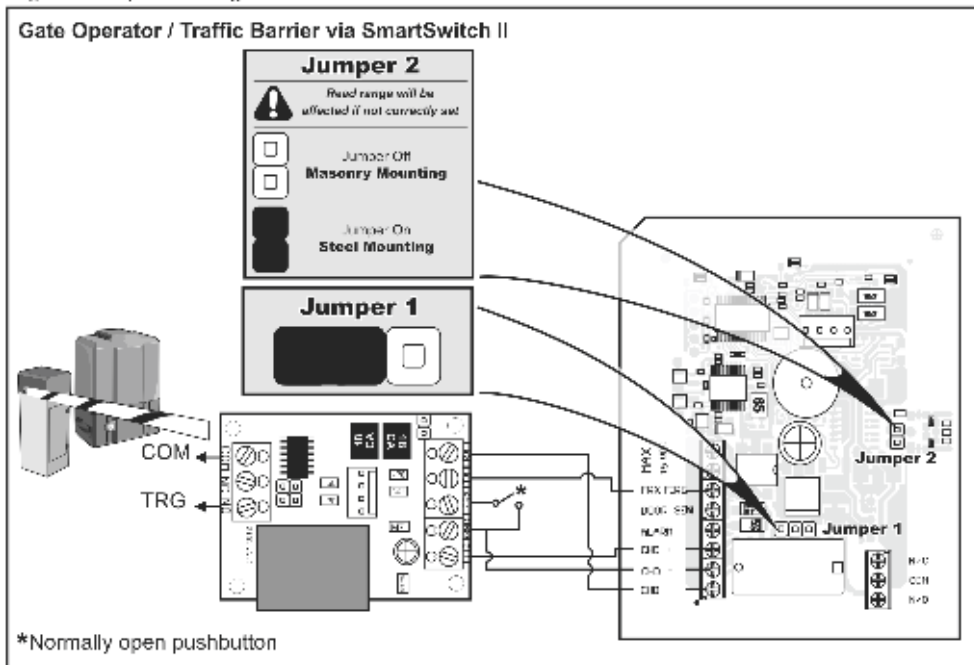

Fig 6. Gate Operator/ Traffic Barrier via SmartSwitch II with secure free exit connection

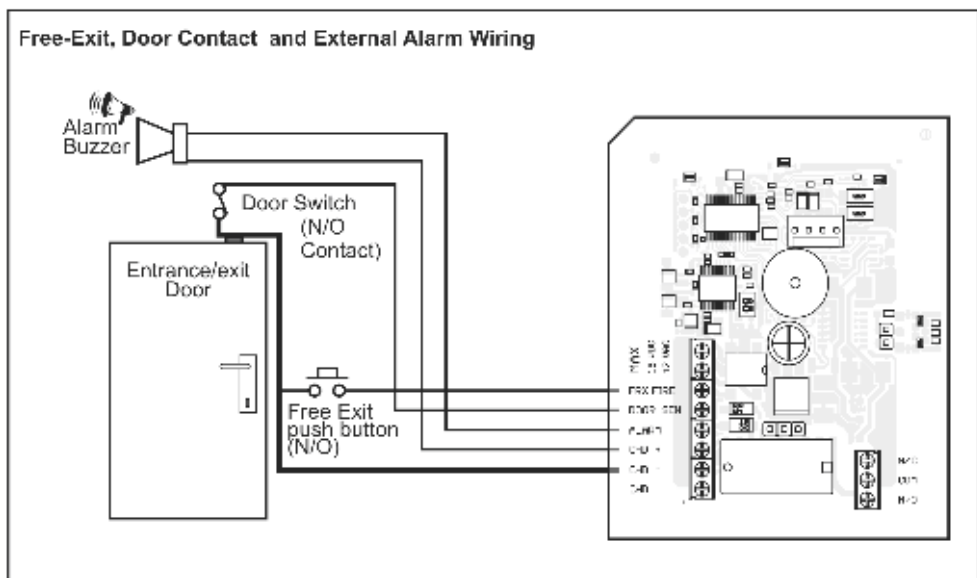

Fig 7. Typical wiring for Free-Exit Pushbutton, Door Contact and External Alarm buzzer

## Explanation of Jumpers

### Jumper 1 - Relay or Smartswitch II enabled

The single channel output of the **SOLO** can be configured to provide a potential free contact either normally-open or normally-closed to operate a door release or activate a gate motor or traffic barrier.

Alternatively the output can be configured to operate with a **CENTSYS SMARTSWITCH II**. The **SMARTSWITCH II** is mounted directly at the door lock or gate motor to provide an even higher level of security by preventing a would-be intruder from tampering with the doorlock/gate trigger lines to gain entry.

**JUMPER 1** is used to determine which facility is enabled.

### Jumper 2 - Wall or Steel Mounting

The read range of the **SOLO** reader the unit can be optimised whether it is being mounted onto a steel surface (ie. inside the **SOLO** anti-knock shield or directly onto a steel post or pedestal) or wood / masonry surface (wooden door frame or plastered/plain brick/stone wall\*)

\*flush mounting into a 4" x 2" light switch box would be regarded as mounting onto a masonry surface.

**Jumper 2** is used to select between the two types of surface.

# Overview of User Interface

On the front face of the **SOLO** Reader there are two rows of indicator lights. These lights are used to communicate/interface with the system user.

The top row consists of an Orange, Green and Red light. The bottom row consists of a Green and Red light only.

During normal operation the five lights indicate various conditions, for example:

A flashing bottom Red light indicates that the **SOLO** Reader is in normal run mode and providing access control. A flashing bottom Green light indicates that the **SOLO** Reader is in Autolearn Mode, etc.

For a detailed explanation of the various light indications status please refer to Table 2 below.

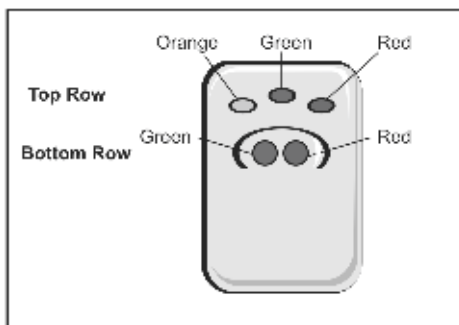

Fig 8 LED Indicators

In Programming Mode the five lights indicate Programming Menu Levels, Configuration Settings, Timer Values, etc.

**Table 2. Explanation of Indicator Lights During Normal Run Mode**

Flashing bottom Red light	Normal Run Mode - Red light acts as a Beacon
Flashing bottom Green light	Autolearn Mode - Green light acts as a Beacon
Flashing top Green light	Relay configured as latching output
Flashing top Red light (1x)	Power supply too low
Flashing top Red light (2x)	Power supply within warning range
Flashing top Red light (3x)	Power supply too high
Flashing top Orange light	Solo Reader faulty - return to Authorised Distributor
Flashing top Orange and Red light	Solo Reader faulty - return to Authorised Distributor

## Identification of Tags

### Find Master Tags

It is important to note that the **SOLO** system can accommodate two MASTER tags used for administering the unit. The primary MASTER tag is stored in memory location 00 and the secondary in 01.

If the MASTER tags have not been clearly marked it is very easy to identify them by presenting the tags momentarily to the reader. Refer to the detailed instructions below.

### Find User Tag Memory Location

If a user tag has not been recorded in the Memory Allocation and Parameter Settings form provided with the kit, then it is very easy to identify this tag's memory location.

See the menu on page 23 for detailed instructions.

# Find Master Tags

**Please Note:**

- **SOLO** Reader remains in Normal Run Mode.
- If either Master Tag is presented to the **SOLO** Reader for longer for than 5 seconds, **PROGRAM MODE** will be entered.

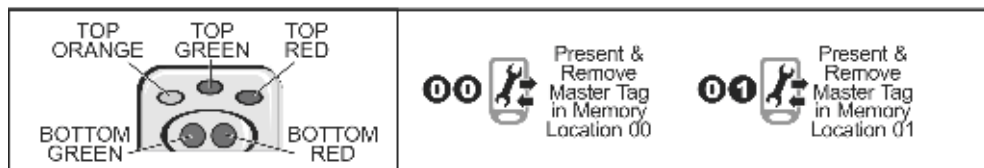

Graphical Instructions		Written Instructions	
1		<b>Present and REMOVE</b> the Master Tag in <b>Memory Location 00</b>	
2	Observe Bottom Lights	<b>BOTTOM GREEN LIGHT</b> and <b>BOTTOM RED LIGHT</b> will turn <b>ON</b> briefly	
3		<b>Present and REMOVE</b> the Master Tag in <b>Memory Location 01</b>	
4		<b>BOTTOM GREEN LIGHT</b> will turn <b>ON</b> briefly	
The <b>SOLO</b> Reader will remain in Normal RUN MODE if Master Tags are presented for less than 5 seconds.			

# Find User Tag Memory Location

## Please Note:

- This procedure is for checking Memory Location of User Tags only
- The **SOLO** Reader remains in Normal Run Mode
- The Memory Location will be repeatedly shown for as long as the User Tag is presented to the **SOLO** Reader.
- Ensure that the Master Tag is not presented to the **SOLO** Reader for longer than 5 seconds or Programme Mode will be entered.
- The **TOP RED LIGHT** will flash momentarily if the presented Tag is not present in the **SOLO**

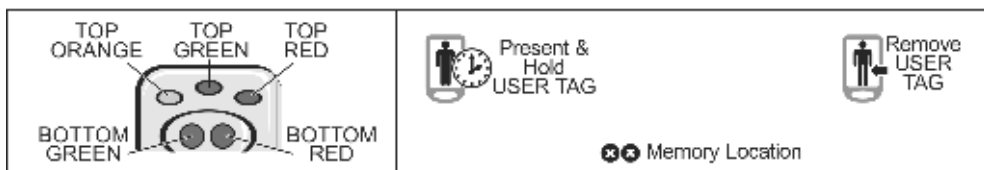

Graphical Instructions		Written Instructions	
1		<b>Present and HOLD</b> a User Tag to the <b>SOLO</b> Reader	
2	Observe Top Lights	<b>TOP GREEN LIGHT</b> and <b>TOP RED LIGHT</b> will FLASH individually	
3	 Short Flash = 0 Flash = x (TENS)	<b>Note:</b> Shor: Flash = 0 <b>Count</b> the number of flashes on the <b>TOP GREEN LIGHT</b> to indicate <b>TENS</b>	
4	 Short Flash = 0 Flash = x (TENS)	<b>Note:</b> Shor: Flash = 0 <b>Count</b> the number of flashes on the <b>TOP RED LIGHT</b> to indicate <b>UNITS</b>	
5		<b>Repeat</b> from step 3 above to confirm counts	
6		<b>Remove</b> the User Tag	
x		<b>Repeat</b> the process for the other User Tags	

The examples on page 22 refer specifically to how Step 3 and 4 above may be applied.

# EXAMPLE

## How to find User Tag Memory Location

	Graphical Instructions	Written Instructions
<b>Example: User Tag in Memory Location 03</b>		
1	<p style="text-align: center;">Short Flash = 0 (TENS)</p> <p style="text-align: center;">Flash x 3 (UNITS)</p>	<p><b>TOP GREEN LIGHT</b> will <b>SHORT FLASH</b> to indicate <b>0 TENS</b></p> <p><b>TOP RED LIGHT</b> will <b>FLASH 3 TIMES</b> to indicate <b>3 UNITS</b></p>
<b>Example: User Tag in Memory Location 30</b>		
2	<p style="text-align: center;">Flash x 3 (TENS)</p> <p style="text-align: center;">Short Flash=0 (UNITS)</p>	<p><b>TOP GREEN LIGHT</b> will <b>FLASH 3 TIMES</b> to indicate <b>30</b></p> <p><b>TOP RED LIGHT</b> will <b>SHORT FLASH</b> to indicate <b>0 UNITS</b></p>
<b>Example: User Tag in Memory Location 36</b>		
3	<p style="text-align: center;">Flash x 3 (TENS)</p> <p style="text-align: center;">Flash x 6 (UNITS)</p>	<p><b>TOP GREEN LIGHT</b> will <b>FLASH 3 TIMES</b> to indicate <b>30</b></p> <p><b>TOP RED LIGHT</b> will <b>FLASH 6 TIMES</b> to indicate <b>6 UNITS</b></p>
<b>Example: User Tag in Memory Location 49</b>		
4	<p style="text-align: center;">Flash x 4 (TENS)</p> <p style="text-align: center;">Flash x 9 (UNITS)</p>	<p><b>TOP GREEN LIGHT</b> will <b>FLASH 4 TIMES</b> to indicate <b>40</b></p> <p><b>TOP RED LIGHT</b> will <b>FLASH 9 TIMES</b> to indicate <b>9 UNITS</b></p>

# Add Tag Menu

---

## Overview

The **SOLO** Reader is capable of storing a total of 51 Zap Tags in Memory Locations 00 to 50. Memory Locations 00 and 01 are reserved for the two Master Tags, either of which is required for adding and deleting Tags, and configuring the **SOLO** Reader.

It is important to note that the primary Master Tag (memory location 00) has greater access rights than the secondary Master Tag (memory location 01). Only the primary Master Tag is capable of clearing the entire memory back to factory defaults as well as clearing all memory locations. This is NOT possible with the secondary Master Tag.

For this reason it is recommended that the primary MASTER Tag is kept in a safe and secure place, while the secondary Master Tag is used for day to day administration and operation of the system.

The **SOLO** Reader allows tags to be added to the system in three ways:

## 1. Quik Add

This option will add new tags to the available Memory Locations sequentially, without displaying the actual Memory Location. Refer to pages 9 and 10 for Quik Add Instructions.

## 2. Add Tag - SOLO Reader specified Memory Location

This option will add tags to available Memory Locations sequentially, while displaying the actual Memory Location.

## 3. Add Tag - User Specified Memory Location

This option will add tags to available Memory Locations selected by the user.

To fully exploit the features of the **SOLO** system, it is necessary to keep an up-to-date record of each user, and the Memory Location in which his/her tag is stored. The Memory Allocation and Parameter Setting form included with this product, should be used to maintain this information. (Refer to the back of the QUIK Installation Manual - pg 16 or print out page 84 of this electronic manual when you need to update the form).

Some of the benefits of having this information available are:

- If a user loses a tag, it can be selectively deleted from the memory.
- If a lost tag is found, its Memory Location can be determined\*, and it can be returned to the correct user.

\* See Page 20.









# Add Tag - SOLO Specified Memory Locations

## Please Note:

- Tags will be added sequentially to the empty Memory Locations of the SOLO Reader. Previous Memory Locations will not be overwritten.
- To ABORT wait for  $\pm 60$  seconds for the SOLO to RESET**







Graphical Instructions		Written Instructions
1	Observe Lights	<b>Present and HOLD</b> either Master Tag until <b>all lights turn ON</b>
2		<b>Remove</b> the Master Tag
3	Observe Top Lights	<b>Top green light</b> will remain on
4	Observe Bottom Lights	Only <b>BOTTOM GREEN LIGHT ON</b> <b>Present and remove</b> the Master Tag
5		<b>TOP GREEN LIGHT</b> and <b>TOP RED LIGHT</b> will FLASH individually to indicate next available memory location
6*	 Short Flash = 0 Flash = x (TENS)	<b>Note:</b> Short Flash = 0 <b>Count</b> the number of flashes on the <b>TOP GREEN LIGHT</b> to indicate <b>TENS</b>
7*	 Short Flash = 0 Flash = x (TENS)	<b>Note:</b> Short Flash = 0 <b>Count</b> the number of flashes on the <b>TOP RED LIGHT</b> to indicate <b>UNITS</b>
8		<b>Present and Remove</b> New Tag to the SOLO Reader

9		The <b>buzzer</b> will sound to indicate a successful addition
10		<b>Repeat from Step 5</b> above for further Tags
<b>To Exit</b>		
11	  	Both <b>BOTTOM GREEN LIGHT ON</b> and <b>BOTTOM RED LIGHT ON</b> <b>Present and remove</b> the Master Tag
12	  	Both <b>BOTTOM GREEN LIGHT ON</b> and <b>BOTTOM RED LIGHT ON</b> <b>Present and remove</b> the Master Tag
The <b>SOLO</b> Reader will enter normal RUN MODE		
It is recommended that the attached Memory Location allocation and Parameter settings form be updated.		
* Counting examples for Memory Locations may be found on page 25		

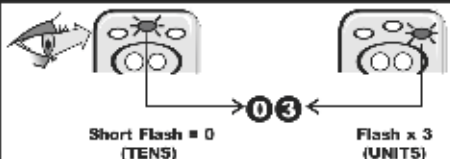
## EXAMPLE

### How to use the LED's to select Memory Locations

	Graphical Instructions	Written Instructions
<b>Example: Value set to 03</b>		
1		<b>TOP GREEN LIGHT</b> will <b>SHORT FLASH</b> to indicate <b>0 TENS</b> <b>TOP RED LIGHT</b> will <b>FLASH 3 TIMES</b> to indicate <b>3 UNITS</b>
<b>Example: Value set to 30</b>		
2		<b>TOP GREEN LIGHT</b> will <b>FLASH 3 TIMES</b> to indicate <b>30</b> <b>TOP RED LIGHT</b> will <b>SHORT FLASH</b> to indicate <b>0 UNITS</b>
<b>Example: Value set to 36</b>		
3		<b>TOP GREEN LIGHT</b> will <b>FLASH 3 TIMES</b> to indicate <b>30</b> <b>TOP RED LIGHT</b> will <b>FLASH 6 TIMES</b> to indicate <b>6 UNITS</b>
<b>Example: Value set to 49</b>		
4		<b>TOP GREEN LIGHT</b> will <b>FLASH 4 TIMES</b> to indicate <b>40</b> <b>TOP RED LIGHT</b> will <b>FLASH 9 TIMES</b> to indicate <b>9 UNITS</b>

# Add Tag - USER Specified Memory Locations

**Please Note:**

- Previous Memory Locations will not be overwritten.
- **To ABORT wait for ± 60 seconds for the SOLO to RESET**

	Present & Hold Master Tag	Remove Master Tag	Present & Remove Master Tag
			Present & Remove New Tag

Graphical Instructions		Written Instructions
1	Observe Lights	<b>Present and HOLD</b> either Master Tag until <b>all lights turn ON</b>
2		<b>Remove</b> the Master Tag
3	Observe Top Lights	<b>Top green light</b> will remain on
4	Observe Bottom Lights	Only <b>BOTTOM GREEN LIGHT ON</b> <b>Present and remove</b> the Master Tag
5		<b>TOP GREEN LIGHT</b> and <b>TOP RED LIGHT</b> will FLASH individually to indicate next available memory location
6*	<p>Short Flash = 0 Flash = x (TENS)</p>	<b>Note:</b> Short Flash = 0 <b>Count</b> the number of flashes on the <b>TOP GREEN LIGHT</b> to indicate <b>TENS</b>
7*	<p>Short Flash = 0 Flash = x (TENS)</p>	<b>Note:</b> Short Flash = 0 <b>Count</b> the number of flashes on the <b>TOP RED LIGHT</b> to indicate <b>UNITS</b>

**To select  
Memory Location**



Only **BOTTOM RED LIGHT ON**  
**Present and HOLD** the Master Tag



On **TOP RED LIGHT** count number of  
flashes required for **UNITS** value.  
**Short Flash=0**



Remove Master Tag when required **UNITS**  
value reached.



Only **TOP RED LIGHT** will remain ON



**Present and HOLD** the Master Tag



On **TOP GREEN LIGHT** count number of  
flashes required for **TENS** value.  
**Short Flash=0**







Remove Master Tag when required **TENS**  
value reached.

**To move forward to next  
available Memory Location**



Only **BOTTOM GREEN LIGHT ON**  
**Present and remove** the Master Tag

8

9*	<b>Confirm the Memory Location you have selected is Correct</b>	
		
<b>To ACCEPT Memory Location</b>		<b>To CHANGE Memory Location</b>
10		Repeat from step 8 above
	<b>Present and remove</b> New Tag	
	<b>To add more tags</b> repeat from step 8 above	
<b>To Exit</b>		
11		Both <b>BOTTOM GREEN LIGHT ON</b> and <b>BOTTOM RED LIGHT ON</b> <b>Present and remove</b> the Master Tag
12		
The <b>SOLO</b> Reader will enter normal RUN MODE		
It is recommended that the attached Memory Location allocation and Parameter settings form be updated.		
* Counting examples for Memory Locations may be found on page 25		

# Delete Tag Menu

---

## Overview

The **SOLO** Reader allows tags to be deleted from the system in four ways.

### 1. Quik Delete

This option erases all tags in memory. Please refer to QUIK Delete Menu on page 11 of this manual.

### 2. Delete Tag - via Memory Location

A benefit of the **SOLO** Reader is the ability to selectively delete user tags from the system. Provided that a record has been kept of the memory location of the user whose tag is required to be deleted, by following this procedure, this tag can be deleted without affecting any of the other tags in the system.

### 3. Delete Tag - via Tag

This option allows the user to remove specific tags from the system by presenting the tag itself.

### 4. Replacing a Master Tag

It is possible to replace a Master Tag provided that the other MASTER Tag is available.

The procedure that follows shows how to replace the secondary MASTER tag (memory location 01) if this is lost. Apply the same procedure to replace the primary MASTER Tag (memory location 00) except at STEP 11. Set the memory location to 00.

### 5. Complete Delete

This option erases all tags in memory, and resets the **SOLO** Reader to factory defaults.

# Delete Tag via Memory Location (Tag not available)









**Please Note:**

- Memory Location of Tag is required for this process
- **To ABORT wait for ± 60 seconds for the SOLO to RESET**



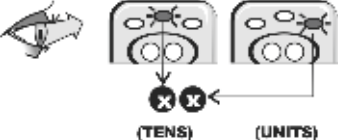

Graphical Instructions		Written Instructions
1	Observe Lights	<b>Present and HOLD</b> either Master Tag until <b>all lights turn ON</b>
2		<b>Remove</b> the Master Tag
3	Observe Top Lights	<b>Top green light</b> will remain on
4	Observe Bottom Lights	Only <b>BOTTOM RED LIGHT ON</b> <b>Present and remove</b> the Master Tag
5		<b>Top red light</b> will turn on
6		Only <b>BOTTOM GREEN LIGHT ON</b> <b>Present and remove</b> the Master Tag
7		<b>Top red light</b> will turn on
8		<b>Present and HOLD</b> the Master Tag
9 <sup>v</sup>		<b>TOP RED LIGHT</b> will flash Count the required number of <b>UNITS</b> Short Flash = 0



10		<b>Remove</b> the Master Tag
11		<b>Present and HOLD</b> the Master Tag
12*		<b>TOP GREEN LIGHT</b> will flash Count the required number of <b>TENS</b> Short Flash = 0
13*		<b>Remove</b> the Master Tag
14		Selected Memory Location indicated by <b>TOP GREEN LIGHT (TENS)</b> and <b>TOP RED LIGHT (UNITS)</b>
<b>To DELETE Memory Location</b>		<b>To CHANGE Memory Location</b>
15		Repeat from <b>Step 8</b> above for further Tags
	Only <b>BOTTOM GREEN LIGHT ON</b> <b>Present and remove</b> the Master Tag	
	Repeat from <b>Step 8</b> above for further Tags	
<b>To EXIT</b>		
16		Both <b>BOTTOM GREEN LIGHT ON</b> and <b>BOTTOM RED LIGHT ON</b> <b>Present and remove</b> the Master Tag
17		Both <b>BOTTOM GREEN LIGHT ON</b> and <b>BOTTOM RED LIGHT ON</b> <b>Present and remove</b> the Master Tag
The <b>SOLO</b> Reader will enter normal RUN MODE		
It is recommended that the attached Memory Location allocation and Parameter settings form be updated.		
* Counting examples for Memory Locations may be found on page 32		

## EXAMPLE

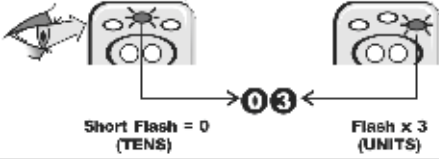
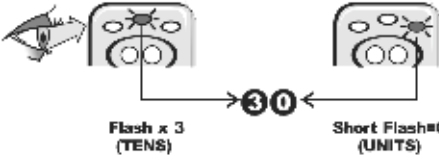
### How to use the LED's to select Memory Locations

	Graphical Instructions	Written Instructions
<b>Example: Value set to 03</b>		
1		<b>TOP GREEN LIGHT</b> will <b>SHORT FLASH</b> to indicate <b>0 TENS</b> <b>TOP RED LIGHT</b> will <b>FLASH 3 TIMES</b> to indicate <b>3 UNITS</b>
<b>Example: Value set to 30</b>		
2		<b>TOP GREEN LIGHT</b> will <b>FLASH 3 TIMES</b> to indicate <b>30</b> <b>TOP RED LIGHT</b> will <b>SHORT FLASH</b> to indicate <b>0 UNITS</b>
<b>Example: Value set to 36</b>		
3		<b>TOP GREEN LIGHT</b> will <b>FLASH 3 TIMES</b> to indicate <b>30</b> <b>TOP RED LIGHT</b> will <b>FLASH 6 TIMES</b> to indicate <b>6 UNITS</b>
<b>Example: Value set to 49</b>		
4		<b>TOP GREEN LIGHT</b> will <b>FLASH 4 TIMES</b> to indicate <b>40</b> <b>TOP RED LIGHT</b> will <b>FLASH 9 TIMES</b> to indicate <b>9 UNITS</b>

# Delete Tag (Tag available)

**Please Note:**

- To **ABORT** wait for  $\pm 60$  seconds for the **SOLO** to **RESET**



Graphical Instructions		Written Instructions
1	Observe Lights	<b>Present and HOLD</b> either Master Tag until <b>all lights turn ON</b>
2		<b>Remove</b> the Master Tag
3	Observe Top Lights	<b>Top green light</b> will remain on
4	Observe Bottom Lights	Only <b>BOTTOM RED LIGHT ON</b> <b>Present and remove</b> the Master Tag
5		<b>Top red light</b> will turn on
6		Only <b>BOTTOM GREEN LIGHT ON</b> <b>Present and remove</b> the Master Tag
7		<b>Top red light</b> will turn on
8		<b>Present and remove User Tag</b> to be deleted.
9*	 (TENS) → X X ← (UNITS)	Memory Location of deleted USER Tag indicated by <b>TOP GREEN LIGHT (TENS) and TOP RED LIGHT (UNITS)</b>

10		Repeat from <b>Step 8</b> above for other Tags as required
11		<b>Present and remove</b> the Master Tag
The <b>SOLO</b> Reader will enter normal RUN MODE		
It is recommended that the attached Memory Location allocation and Parameter settings form be updated.		
* Counting examples for Memory Locations may be found on page 32		

# Replacing Master Tag in Memory Location 01 (Secondary Master Tag)

**Please Note:**

- Master Tag in Memory Location 00 must be used for this procedure.
- To **ABORT** wait for  $\pm 60$  seconds for the **SOLO** to **RESET**



Graphical Instructions		Written Instructions	
1	Observe Lights		<b>Present and HOLD</b> Master Tag in Memory Location 00 until <b>all lights turn ON</b>
2			<b>Remove</b> the Master Tag
3	Observe Top Lights		<b>Top green light</b> will remain on
4	Observe Bottom Lights		Only <b>BOTTOM RED LIGHT ON</b> <b>Present and remove</b> the Master Tag
5			<b>Top red light</b> will turn on
6			Only <b>BOTTOM GREEN LIGHT ON</b> <b>Present and remove</b> the Master Tag
7			<b>Top red light</b> will turn on
8			<b>Present and HOLD</b> the Master Tag
9*			<b>TOP RED LIGHT</b> will flash Count the required number of <b>UNITS (1)</b> Short Flash = 0
10			<b>Remove</b> the Master Tag

11		<b>Present and remove</b> the Master Tag
12*		<p>Selected Memory Location 01 indicated by <b>TOP GREEN LIGHT</b> Single Flash and <b>TOP RED LIGHT</b> Short Flash</p>
13		Only <b>BOTTOM GREEN LIGHT ON</b> <b>Present and remove</b> the Master Tag
14		Both <b>BOTTOM GREEN LIGHT ON</b> and <b>BOTTOM RED LIGHT ON</b> <b>Present and remove</b> the Master Tag
15		Both <b>BOTTOM GREEN LIGHT ON</b> and <b>BOTTOM RED LIGHT ON</b> <b>Present and remove</b> the Master Tag
16		<b>Present and HOLD</b> Master Tag in Memory Location 00 until <b>all lights turn ON</b>
17		<b>Remove</b> the Master Tag
18		<b>Top green light</b> will remain on
19		<b>Present and remove</b> the <b>NEW</b> Master Tag
20		<b>TOP GREEN LIGHT</b> will flash and the <b>BUZZER</b> will sound to indicate a successful addition.
21		<b>Present and REMOVE</b> either Master Tag

The **SOLO** Reader will enter normal RUN MODE

It is recommended that the attached Memory Location allocation and Parameter settings form be updated.

Please note that the primary Master Tag (memory location 00) has greater access rights than the secondary Master Tag (memory location 01). Only the primary Master Tag is capable of clearing the entire memory back to factory defaults as well as clearing all memory locations. This is NOT possible with the secondary Master Tag.

\* Counting examples for Memory Locations may be found on page 32

# Replacing Master Tag in Memory Location 00 (Primary Master Tag)

## Please Note:

- Master Tag in Memory Location 01 must be used for this procedure.
- To **ABORT** wait for  $\pm 60$  seconds for the **SOLO** to **RESET**

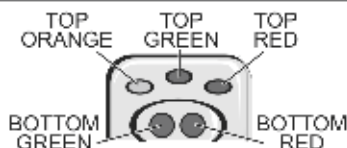

Present & Hold Master Tag



Remove Master Tag



Present & Remove Master Tag





















01







Master Tag in Memory Location 01 (Secondary)

### Graphical Instructions

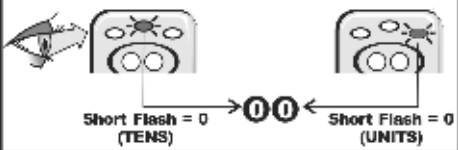
### Written Instructions

1	Observe Lights   	<b>Present and HOLD</b> Master Tag in Memory Location 01 until <b>all lights turn ON</b>
2		<b>Remove</b> the Master Tag
3	Observe Top Lights  	<b>Top green light</b> will remain on
4	Observe Bottom Lights   	Only <b>BOTTOM RED LIGHT ON</b> <b>Present and remove</b> the Master Tag
5	 	<b>Top red light</b> will turn on
6	  	Only <b>BOTTOM GREEN LIGHT ON</b> <b>Present and remove</b> the Master Tag
7	 	<b>Top red light</b> will turn on
8		<b>Present and remove</b> the Master Tag
9	 	<b>Top red light</b> will remain on
10		<b>Present and remove</b> the Master Tag

11		<p>Selected Memory Location 00 indicated by  <b>TOP GREEN LIGHT</b> Short Flash and  <b>TOP RED LIGHT</b> Short Flash</p>
12		<p>Only <b>BOTTOM GREEN LIGHT ON</b>  <b>Present and remove</b> the Master Tag</p>
13		<p><b>Top lights will FLASH</b></p>
14		<p><b>Present and remove</b> the NEW Master Tag</p>
<p>The <b>SOLO</b> Reader will enter normal RUN MODE</p>		
<p>It is recommended that the attached Memory Location allocation and Parameter settings form be updated.</p>		



# Complete Delete

## Please Note:

- Master Tag in Memory Location 00 must be used for this procedure.
- All Tags will be deleted from the **SOLO** Reader.
- All parameters will be restored to the Factory Default Settings.
- **To ABORT wait for ± 60 seconds for the SOLO to RESET**

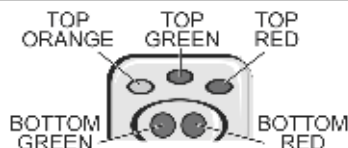

Present & Hold Master Tag



Remove Master Tag



Present & Remove Master Tag



























00







Master Tag in Memory Location 00 (Primary)

## Graphical Instructions

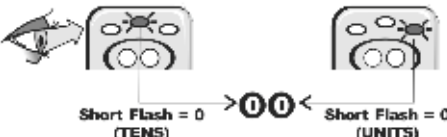
## Written Instructions

1	Observe Lights  	  <p><b>Present and HOLD</b> Master Tag in Memory Location 00 until <b>all lights turn ON</b></p>
2		  <p><b>Remove</b> the Master Tag</p>
3	Observe Top Lights  	<p><b>Top green light</b> will remain on</p>
4	Observe Bottom Lights  	  <p>Only <b>BOTTOM RED LIGHT ON</b> <b>Present and remove</b> the Master Tag</p>
5	 	<p><b>Top red light</b> will turn on</p>
6	 	  <p>Only <b>BOTTOM GREEN LIGHT ON</b> <b>Present and remove</b> the Master Tag</p>
7	 	<p><b>Top red light</b> will turn on</p>
8		  <p><b>Present and remove</b> the Master Tag</p>
9	 	<p><b>Top red light</b> will remain on</p>

10		<p><b>Present and remove</b> the Master Tag</p>
11		<p>Selected Memory Location 00 indicated by  <b>TOP GREEN LIGHT</b> Short Flash and  <b>TOP RED LIGHT</b> Short Flash</p>
12		<p>Only <b>BOTTOM GREEN LIGHT ON</b>  <b>Present and HOLD</b> the Master Tag</p>
13		<p>All the lights begin to Flash  <b>Continue to HOLD</b> the Master Tag</p>
14		<p><b>WAIT</b> for all the lights to turn <b>OFF</b></p>
15		<p><b>Remove</b> the Master Tag  All Tags are deleted. Top row lights will chase each other.</p>

# Configuration Menu

## Overview

The Configuration Menu of the **SOLO** Reader allows for seven configuration options to be turned ON or OFF individually as required for each installation. The Configuration Options have been Factory preset to the most common settings.

CONFIGURATION FACTORY SETTINGS	
Tag Buzzer	ON
Free-Exit Input	ON
Door Forced Alarm Output	OFF
Door Forced Alarm Buzzer	OFF
Door Open Alarm Output	OFF
Door Open Alarm Buzzer	OFF
Smartswitch II	OFF

Table 3. Configuration Factory Settings

### 1. Configuration Option 1 - TAG BUZZER

*(Factory Default ON)*

When a valid\* Zap Tag is presented, the Tag Buzzer provides a brief audible indication that access has been granted. The Tag Buzzer can be turned OFF if no audible indication is required.

### 2. Configuration Option 2 - FREE EXIT (FRX)

*(Factory Default ON)*

The FREE-EXIT (FRX) input allows activation of the reader without using a valid\* Zap Tag. With the FRX option turned ON, activating a "Push to Make" contact connected to the FRX input will cause the reader to activate as if a valid\* Zap Tag has been presented. (Refer to Figure 7 on page 19 for connection method.)

**NOTE:** In order to prevent unauthorised access, it is recommended that FRX be turned OFF if not required.

### 3. Configuration Option 3 - DOOR FORCED ALARM OUTPUT

*(Factory Default OFF)*

If turned ON, the DOOR FORCED ALARM OUTPUT option activates the ALARM output immediately when the access point being controlled by the **SOLO** Reader has been forced open\*. The ALARM terminal provides a common ground Open Collector output capable of sinking a MAXIMUM current of 50mA at 17 volt DC, and can be connected to a third party alarm system, external siren, etc.

Please read the Timer Menu options relevant to Door Forced Alarm Time.

\*A working Zap Tag that has been previously added to a Memory Location of the **SOLO** Reader

---

## 4. Configuration Option 4 - DOOR FORCED ALARM BUZZER

*(Factory Default OFF)*

If turned ON, the DOOR FORCED ALARM BUZZER option activates the built in buzzer when the access point being controlled by the **SOLO** Reader has been forced open .

Please read the Timer Menu options relevant to Door Forced Alarm Time.

## 5. Configuration Option 5 - DOOR OPEN ALARM OUTPUT

*(Factory Default OFF)*

If turned ON, the Door Open Alarm Output option activates the ALARM output when the access point being controlled by the **SOLO** Reader has been left open longer than the configurable door open time . The ALARM terminal provides a common ground Open Collector output capable of sinking a MAXIMUM current of 50mA at 17V DC, and can be connected to a third party alarm system, external siren, etc.

Please read the Timer Menu options relevant to Door Forced Open Alarm Time.

## 6. Configuration Option 6 - DOOR OPEN ALARM BUZZER

*(Factory Default OFF)*

If turned ON, the Door Open Alarm Buzzer option activates the built-in buzzer when the access point being controlled by the **SOLO** Reader has been left open for longer than the configurable door open time<sup>1</sup>.

Please read the Timer Menu options relevant to Door Open Time and Door Open Alarm Time.

## 7. Configuration Option 7 - SMARTSWITCH II

*(Factory Default OFF)*

Use of an optional **SMARTSWITCH II** is recommended where extra security is needed to prevent unauthorized operation of the access point. The **SMARTSWITCH II** will only operate correctly if the **SMARTSWITCH II** option is turned on AND the relay selection jumper on the **SOLO** Reader is fitted to the correct pins. Refer to Figure 1 on page 8 for the connection method.

<sup>1</sup>For the various alarm options to function correctly, the **SOLO** Reader must be powered, in proper working order and have a normally open switch connected. Refer to Fig 7 on page 19 for the connection method.



### Tips & Tricks

To change multiple options in the Configuration Menu DO NOT perform the last two instructions in the various Configuration Menu Options.

Once you have performed the first instruction after turning ON or OFF the various options, you may continue from step 9 for the next configurable option by matching up the light display.

# Turning the TAG BUZZER ON or OFF

**Please Note:**

- To **ABORT** wait for  $\pm 60$  seconds for the **SOLO** to **RESET**

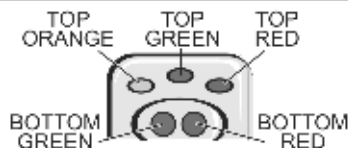

Present & Hold Master Tag



Remove Master Tag









Present & Remove Master Tag

## Graphical Instructions

## Written Instructions

1	Observe Lights			<b>Present and HOLD</b> either Master Tag until <b>all lights turn ON</b>
2				<b>Remove</b> the Master Tag
3	Observe Top Lights			<b>Top green light</b> will remain on
4	Observe Bottom Lights			Only <b>BOTTOM RED LIGHT ON</b> <b>Present and remove</b> the Master Tag
5				<b>Top red light</b> will turn on
6				Only <b>BOTTOM RED LIGHT ON</b> <b>Present and remove</b> the Master Tag
7				<b>Top orange light</b> will turn on
8				Only <b>BOTTOM GREEN LIGHT ON</b> <b>Present and remove</b> the Master Tag
9				<b>Top red light</b> will turn on
10				Only <b>BOTTOM GREEN LIGHT ON</b> <b>Present and remove</b> the Master Tag
11				<b>Top red light</b> will remain on

<b>To turn the BUZZER ON</b>		<b>To turn the BUZZER OFF</b>	
12			
	Only <b>BOTTOM GREEN LIGHT ON</b> Present and remove the Master Tag	Only <b>BOTTOM RED LIGHT ON</b> Present and remove the Master Tag	
			
<b>Bottom green light will flash</b> to indicate the TAG BUZZER is <b>ON</b>		<b>Bottom red light will flash</b> to indicate the TAG BUZZER is <b>OFF</b>	

13		Both <b>BOTTOM GREEN LIGHT ON</b> and <b>BOTTOM RED LIGHT ON</b> Present and remove the Master Tag
14		Both <b>BOTTOM GREEN LIGHT ON</b> and <b>BOTTOM RED LIGHT ON</b> Present and remove the Master Tag
15		Both <b>BOTTOM GREEN LIGHT ON</b> and <b>BOTTOM RED LIGHT ON</b> Present and remove the Master Tag

The **SOLO** Reader will enter normal RUN MODE

It is recommended that the attached Memory Location allocation and Parameter settings form be updated.

Tips and tricks for **SOLO** Configuration Menu on page 44



### NORMAL MODE

For Tag Location, present & HOLD Tag  
for  $\pm 3$  seconds

enter PROGRAMMING  
MODE



NORMAL  
PROGRAMMING  
MODE

QUIK FACTORY  
PARAMETER  
DEFAULT



TURBO  
PROGRAMMING  
MODE



AUTO-LEARN  
LIMITED  
TIME



AUTO-LEARN  
UNLIMITED  
TIME



# ADVANCED USER MENU MAP





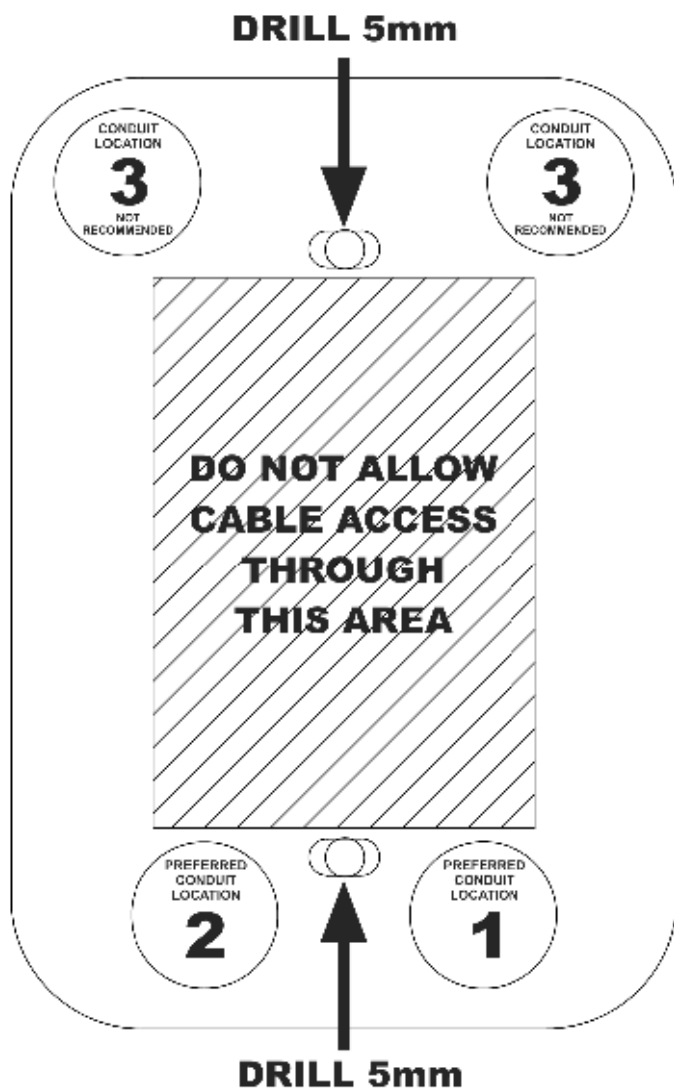

**SURFACE MOUNT INSTALLATION**

**This mounting template is to be used when performing a surface mount installation. (Remove template from book)**

- When planning where to locate the unit, it is important to consider the cable entry position. Do not allow cables to enter the unit through the centre area as this will interfere with assembly of the unit after installation.
- Place the template in such a manner that conduit, where provided, will be behind one of the four preferred conduit locations shown alongside. If conduit is not provided, surface mounted cabling should be planned to enter the unit through one of the 4 preferred locations indicated.
- The conduit locations are indicated in order of preference. Location 1 being the most preferable cable entry location and location 3 being the least preferable cable entry location.



**QUIK ADD** 

**ADD TAG** 

SOLO SPECIFIED  
MEMORY LOCATION

USER SPECIFIED  
MEMORY LOCATION

**DELETE TAG** 

QUIK DELETE  
TAGS ONLY

USER SPECIFIED  
MEMORY LOCATION

DELETE TAG

COMPLETE DELETE  
TAG & FACTORY DEFAULT

**CONFIG** 

TAG BUZZER 

FRX 

EXTERNAL ALARM  
DOOR FORCED 

LOCAL ALARM  
DOOR FORCED 

EXTERNAL ALARM  
DOOR OPEN 

LOCAL ALARM  
DOOR OPEN 

SMARTSWITCH II  
ON or OFF 

**TIMERS** 

RELAY 

DOOR OPEN 

PRE-WARN 

DOOR OPEN ALARM 

DOOR FORCED  
ALARM 

HOLD OFF  
TIME 



# Turning the FREE EXIT ON or OFF











## Please Note:

- To **ABORT** wait for  $\pm 60$  seconds for the **SOLO** to **RESET**



Graphical Instructions		Written Instructions
1	Observe Lights	<b>Present and HOLD</b> either Master Tag until <b>all lights turn ON</b>
2		<b>Remove</b> the Master Tag
3	Observe Top Lights	<b>Top green light</b> will remain on
4	Observe Bottom Lights	Only <b>BOTTOM RED LIGHT ON</b> <b>Present and remove</b> the Master Tag
5		<b>Top red light</b> will turn on
6		Only <b>BOTTOM RED LIGHT ON</b> <b>Present and remove</b> the Master Tag
7		<b>Top orange light</b> will turn on
8		Only <b>BOTTOM GREEN LIGHT ON</b> <b>Present and remove</b> the Master Tag
9		<b>Top red light</b> will turn on
10		Only <b>BOTTOM RED LIGHT ON</b> <b>Present and remove</b> the Master Tag
11		<b>Top green light</b> will turn on

12		Only <b>BOTTOM GREEN LIGHT ON</b> <b>Present and remove</b> the Master Tag
13		<b>Top green light</b> will remain on
<b>To turn FREE EXIT (FRX) ON</b>		<b>To turn FREE EXIT (FRX) OFF</b>
14		
	Only <b>BOTTOM GREEN LIGHT ON</b> <b>Present and remove</b> the Master Tag	Only <b>BOTTOM RED LIGHT ON</b> <b>Present and remove</b> the Master Tag
		
	<b>Bottom green light</b> will flash to indicate the FREE EXIT is <b>ON</b>	<b>Bottom red light</b> will flash to indicate the FREE-EXIT is <b>OFF</b>
15		Both <b>BOTTOM GREEN LIGHT ON</b> and <b>BOTTOM RED LIGHT ON</b> <b>Present and remove</b> the Master Tag
16		Both <b>BOTTOM GREEN LIGHT ON</b> and <b>BOTTOM RED LIGHT ON</b> <b>Present and remove</b> the Master Tag
17		Both <b>BOTTOM GREEN LIGHT ON</b> and <b>BOTTOM RED LIGHT ON</b> <b>Present and remove</b> the Master Tag
The <b>SOLO</b> Reader will enter normal RUN MODE		
It is recommended that the attached Memory Location allocation and Parameter settings form be updated.		
Tips and tricks for <b>SOLO</b> Configuration Menu on page 44		



# Turning DOOR FORCED ALARM OUTPUT ON or OFF











## Please Note:



- To **ABORT** wait for  $\pm 60$  seconds for the **SOLO** to **RESET**



Graphical Instructions		Written Instructions
1	Observe Lights	<b>Present and HOLD</b> either Master Tag until <b>all lights turn ON</b>
2		<b>Remove</b> the Master Tag
3	Observe Top Lights	<b>Top green light</b> will remain on
4	Observe Bottom Lights	Only <b>BOTTOM RED LIGHT ON</b> <b>Present and remove</b> the Master Tag
5		<b>Top red light</b> will turn on
6		Only <b>BOTTOM RED LIGHT ON</b> <b>Present and remove</b> the Master Tag
7		<b>Top orange light</b> will turn on
8		Only <b>BOTTOM GREEN LIGHT ON</b> <b>Present and remove</b> the Master Tag
9		<b>Top red light</b> will turn on
10		Only <b>BOTTOM RED LIGHT ON</b> <b>Present and remove</b> the Master Tag
11		<b>Top green light</b> will turn on

12		Only <b>BOTTOM RED LIGHT ON</b> <b>Present and remove</b> the Master Tag
13		<b>Top green</b> and <b>top red light</b> will turn on
14		Only <b>BOTTOM GREEN LIGHT ON</b> <b>Present and remove</b> the Master Tag
15		<b>Top green</b> and <b>top red light</b> will remain on

<b>To turn DOOR FORCED ALARM OUTPUT ON</b>		<b>To turn DOOR FORCED ALARM OUTPUT OFF</b>	
16			
	Only <b>BOTTOM GREEN LIGHT ON</b> <b>Present and remove</b> the Master Tag	Only <b>BOTTOM RED LIGHT ON</b> <b>Present and remove</b> the Master Tag	
			
	<b>Bottom green light</b> will flash to indicate DOOR FORCED ALARM OUTPUT is <b>ON</b>	<b>Bottom red light</b> will flash to indicate DOOR FORCED ALARM OUTPUT is <b>OFF</b>	

17		Both <b>BOTTOM GREEN LIGHT ON</b> and <b>BOTTOM RED LIGHT ON</b> <b>Present and remove</b> the Master Tag
18		Both <b>BOTTOM GREEN LIGHT ON</b> and <b>BOTTOM RED LIGHT ON</b> <b>Present and remove</b> the Master Tag
19		Both <b>BOTTOM GREEN LIGHT ON</b> and <b>BOTTOM RED LIGHT ON</b> <b>Present and remove</b> the Master Tag

The **SOLO** Reader will enter normal RUN MODE

It is recommended that the attached Memory Location allocation and Parameter settings form be updated.

Tips and tricks for **SOLO** Configuration Menu on page 44

# Turning DOOR FORCED ALARM BUZZER ON or OFF















## Please Note:

- To **ABORT** wait for  $\pm 60$  seconds for the **SOLO** to **RESET**



Graphical Instructions		Written Instructions
1	Observe Lights	<b>Present and HOLD</b> either Master Tag until <b>all lights turn ON</b>
2		<b>Remove</b> the Master Tag
3	Observe Top Lights	<b>Top green light</b> will remain on
4	Observe Bottom Lights	Only <b>BOTTOM RED LIGHT ON</b> <b>Present and remove</b> the Master Tag
5		<b>Top red light</b> will turn on
6		Only <b>BOTTOM RED LIGHT ON</b> <b>Present and remove</b> the Master Tag
7		<b>Top orange light</b> will turn on
8		Only <b>BOTTOM GREEN LIGHT ON</b> <b>Present and remove</b> the Master Tag
9		<b>Top red light</b> will turn on
10		Only <b>BOTTOM RED LIGHT ON</b> <b>Present and remove</b> the Master Tag
11		<b>Top green light</b> will turn on

12		Only <b>BOTTOM RED LIGHT ON</b> <b>Present and remove</b> the Master Tag
13		<b>Top green</b> and <b>top red light</b> will turn on
14		Only <b>BOTTOM RED LIGHT ON</b> <b>Present and remove</b> the Master Tag
15		<b>Top orange light</b> will turn on
16		Only <b>BOTTOM GREEN LIGHT ON</b> <b>Present and remove</b> the Master Tag
17		<b>Top orange light</b> will remain on
18	<b>To turn DOOR FORCED ALARM BUZZER ON</b>	
		
	Only <b>BOTTOM GREEN LIGHT ON</b> <b>Present and remove</b> the Master Tag	Only <b>BOTTOM RED LIGHT ON</b> <b>Present and remove</b> the Master Tag
		
	<b>Bottom green light</b> will flash to indicate DOOR FORCED ALARM BUZZER is <b>ON</b>	<b>Bottom red light</b> will flash to indicate DOOR FORCED ALARM BUZZER is <b>OFF</b>
19		Both <b>BOTTOM GREEN LIGHT ON</b> and <b>BOTTOM RED LIGHT ON</b> <b>Present and remove</b> the Master Tag
20		Both <b>BOTTOM GREEN LIGHT ON</b> and <b>BOTTOM RED LIGHT ON</b> <b>Present and remove</b> the Master Tag
21		Both <b>BOTTOM GREEN LIGHT ON</b> and <b>BOTTOM RED LIGHT ON</b> <b>Present and remove</b> the Master Tag
The <b>SOLO</b> Reader will enter normal RUN MODE		
It is recommended that the attached Memory Location allocation and Parameter settings form be updated.		
Tips and tricks for <b>SOLO</b> Configuration Menu on page 44		

# Turning DOOR OPEN ALARM OUTPUT ON or OFF



















## Please Note:





- To **ABORT** wait for  $\pm 60$  seconds for the **SOLO** to **RESET**



Graphical Instructions		Written Instructions
1	Observe Lights	<b>Present and HOLD</b> either Master Tag until <b>all lights turn ON</b>
2		<b>Remove</b> the Master Tag
3	Observe Top Lights	<b>Top green light</b> will remain on
4	Observe Bottom Lights	Only <b>BOTTOM RED LIGHT ON</b> <b>Present and remove</b> the Master Tag
5		<b>Top red light</b> will turn on
6		Only <b>BOTTOM RED LIGHT ON</b> <b>Present and remove</b> the Master Tag
7		<b>Top orange light</b> will turn on
8		Only <b>BOTTOM GREEN LIGHT ON</b> <b>Present and remove</b> the Master Tag
9		<b>Top red light</b> will turn on
10		Only <b>BOTTOM RED LIGHT ON</b> <b>Present and remove</b> the Master Tag
11		<b>Top green light</b> will turn on

12			Only <b>BOTTOM RED LIGHT ON</b> <b>Present and remove</b> the Master Tag
13			<b>Top green</b> and <b>top red light</b> will turn on
14			Only <b>BOTTOM RED LIGHT ON</b> <b>Present and remove</b> the Master Tag
15			<b>Top orange light</b> will turn on
16			Only <b>BOTTOM RED LIGHT ON</b> <b>Present and remove</b> the Master Tag
17			<b>Top orange</b> and <b>top red light</b> will turn on
18			Only <b>BOTTOM GREEN LIGHT ON</b> <b>Present and remove</b> the Master Tag
19			<b>Top orange</b> and <b>top red light</b> will remain on

<b>To turn DOOR OPEN ALARM OUTPUT ON</b>		<b>To turn DOOR OPEN ALARM OUTPUT OFF</b>	
20			Only <b>BOTTOM RED LIGHT ON</b> <b>Present and remove</b> the Master Tag
			Only <b>BOTTOM GREEN LIGHT ON</b> <b>Present and remove</b> the Master Tag
			<b>Bottom red light</b> will flash to indicate DOOR OPEN ALARM OUTPUT is <b>OFF</b>
			<b>Bottom green light</b> will flash to indicate DOOR OPEN ALARM OUTPUT is <b>ON</b>

21			Both <b>BOTTOM GREEN LIGHT ON</b> and <b>BOTTOM RED LIGHT ON</b> <b>Present and remove</b> the Master Tag
22			Both <b>BOTTOM GREEN LIGHT ON</b> and <b>BOTTOM RED LIGHT ON</b> <b>Present and remove</b> the Master Tag

23



**BOTTOM RED LIGHT ON**  
**Present and remove** the Master Tag

The **SOLO** Reader will enter normal RUN MODE

It is recommended that the attached Memory Location allocation and Parameter settings form be updated.

Tips and tricks for **SOLO** Configuration Menu on page 44

# Turning DOOR OPEN ALARM BUZZER ON or OFF

**Please Note:**

- To **ABORT** wait for  $\pm 60$  seconds for the **SOLO** to **RESET**

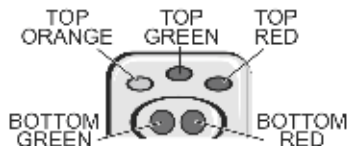

Present & Hold Master Tag



Remove Master Tag















Present & Remove Master Tag





## Graphical Instructions

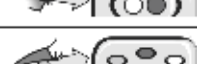
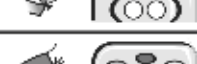

## Written Instructions

1	Observe Lights			<b>Present and HOLD</b> either Master Tag until <b>all lights turn ON</b>
2				<b>Remove</b> the Master Tag
3	Observe Top Lights			<b>Top green light</b> will remain on
4	Observe Bottom Lights			Only <b>BOTTOM RED LIGHT ON</b> <b>Present and remove</b> the Master Tag
5				<b>Top red light</b> will turn on
6				Only <b>BOTTOM RED LIGHT ON</b> <b>Present and remove</b> the Master Tag
7				<b>Top orange light</b> will turn on
8				Only <b>BOTTOM GREEN LIGHT ON</b> <b>Present and remove</b> the Master Tag
9				<b>Top red light</b> will turn on
10				Only <b>BOTTOM RED LIGHT ON</b> <b>Present and remove</b> the Master Tag
11				<b>Top green light</b> will turn on



12			Only <b>BOTTOM RED LIGHT ON</b> <b>Present and remove</b> the Master Tag
13			<b>Top green</b> and <b>top red light</b> will turn on
14			Only <b>BOTTOM RED LIGHT ON</b> <b>Present and remove</b> the Master Tag
15			<b>Top orange light</b> will turn on
16			Only <b>BOTTOM RED LIGHT ON</b> <b>Present and remove</b> the Master Tag
17			<b>Top orange</b> and <b>top red light</b> will turn on
18			Only <b>BOTTOM RED LIGHT ON</b> <b>Present and remove</b> the Master Tag
19			<b>Top orange light</b> and <b>top green light</b> will turn on
20			Only <b>BOTTOM GREEN LIGHT ON</b> <b>Present and remove</b> the Master Tag
21			<b>Top orange light</b> and <b>top green light</b> will remain on

<b>To turn DOOR OPEN ALARM BUZZER ON</b>		<b>To turn DOOR OPEN ALARM BUZZER OFF</b>		
<b>22</b>				
	Only <b>BOTTOM GREEN LIGHT ON</b> <b>Present and remove</b> the Master Tag		Only <b>BOTTOM RED LIGHT OFF</b> <b>Present and remove</b> the Master Tag	
				
<b>Bottom green light</b> will flash to indicate DOOR OPEN ALARM BUZZER is <b>ON</b>		<b>Bottom red light</b> will flash to indicate DOOR OPEN ALARM BUZZER is <b>OFF</b>		

23		Both <b>BOTTOM GREEN LIGHT ON</b> and <b>BOTTOM RED LIGHT ON</b> <b>Present and remove</b> the Master Tag
24		Both <b>BOTTOM GREEN LIGHT ON</b> and <b>BOTTOM RED LIGHT ON</b> <b>Present and remove</b> the Master Tag
25		Both <b>BOTTOM GREEN LIGHT ON</b> and <b>BOTTOM RED LIGHT ON</b> <b>Present and remove</b> the Master Tag
The <b>SOLO</b> Reader will enter normal RUN MODE		
It is recommended that the attached Memory Location allocation and Parameter settings form be updated.		
Tips and tricks for <b>SOLO</b> Configuration Menu on page 44		

# Turning SMARTSWITCH II ON or OFF

## Please Note:

- To **ABORT** wait for  $\pm 60$  seconds for the **SOLO** to **RESET**

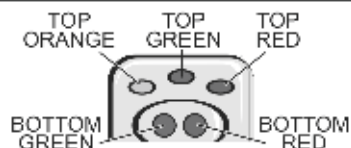

Present & Hold Master Tag





















Remove Master Tag



Present & Remove Master Tag

Graphical Instructions		Written Instructions	
1	Observe Lights		<b>Present and HOLD</b> either Master Tag until <b>all lights turn ON</b>
2			<b>Remove</b> the Master Tag
3	Observe Top Lights		<b>Top green light</b> will remain on
4	Observe Bottom Lights		Only <b>BOTTOM RED LIGHT ON</b> <b>Present and remove</b> the Master Tag
5			<b>Top red light</b> will turn on
6			Only <b>BOTTOM RED LIGHT ON</b> <b>Present and remove</b> the Master Tag
7			<b>Top orange light</b> will turn on
8			Only <b>BOTTOM GREEN LIGHT ON</b> <b>Present and remove</b> the Master Tag
9			<b>Top red light</b> will turn on
10			Only <b>BOTTOM RED LIGHT ON</b> <b>Present and remove</b> the Master Tag
11			<b>Top green light</b> will turn on

12		Only <b>BOTTOM RED LIGHT ON</b> <b>Present and remove</b> the Master Tag
13		<b>Top green</b> and <b>top red light</b> will turn on
14		Only <b>BOTTOM RED LIGHT ON</b> <b>Present and remove</b> the Master Tag
15		<b>Top orange light</b> will turn on
16		Only <b>BOTTOM RED LIGHT ON</b> <b>Present and remove</b> the Master Tag
17		<b>Top orange</b> and <b>top red light</b> will turn on
18		Only <b>BOTTOM RED LIGHT ON</b> <b>Present and remove</b> the Master Tag
19		<b>Top orange</b> and <b>top green light</b> will turn on
20		Only <b>BOTTOM RED LIGHT ON</b> <b>Present and remove</b> the Master Tag
21		<b>Top orange,</b> <b>top green</b> and <b>top red light</b> will turn on
22		Only <b>BOTTOM GREEN LIGHT ON</b> <b>Present and remove</b> the Master Tag
23		<b>Top orange,</b> <b>top green</b> and <b>top red light</b> will remain on

<b>To turn SMARTSWITCH II ON</b>		<b>To turn SMARTSWITCH II OFF</b>	
<b>24</b>			
	Only <b>BOTTOM GREEN LIGHT ON</b> Present and remove the Master Tag	Only <b>BOTTOM RED LIGHT ON</b> Present and remove the Master Tag	
			
	<b>Bottom green light will flash</b> to indicate SMARTSWITCH II is <b>ON</b>	<b>Bottom red light will flash</b> to indicate SMARTSWITCH II is <b>OFF</b>	
<b>25</b>		Both <b>BOTTOM GREEN LIGHT ON</b> and <b>BOTTOM RED LIGHT ON</b> Present and remove the Master Tag	
<b>26</b>		Both <b>BOTTOM GREEN LIGHT ON</b> and <b>BOTTOM RED LIGHT ON</b> Present and remove the Master Tag	
<b>27</b>		Both <b>BOTTOM GREEN LIGHT ON</b> and <b>BOTTOM RED LIGHT ON</b> Present and remove the Master Tag	
The <b>SOLO</b> Reader will enter normal RUN MODE			
It is recommended that the attached Memory Location allocation and Parameter settings form be updated.			
Tips and tricks for <b>SOLO</b> Configuration Menu on page 44			

# Timers Menu

---

## Overview

The Timers Menu of the **SOLO** Reader allows 5 timer values to be changed individually as required for each installation. The various Timer values have been factory preset to the most commonly used values.

FACTORY DEFAULT TIMER VALUES	
Relay Time	1 Second
Door Open Time	5 Seconds
Door Open Pre-warn Time	0 Seconds
Door Open Alarm Time	30 Seconds
Door Forced Alarm Time	Continuous/Latched
Hold Off Time	0 Seconds

*Table 4. Factory Default Timer Values*

### 1. Timer Option 1 - Relay Time

*(Factory Default - 1 Second)*

This is the time for which the onboard Relay, remote relay or **Smartswitch II** will activate when a valid Tag is presented. The timer can be set to Pulsed, Latching or OFF, depending on its value.

See Table 5 for various settings.

### 2. Timer Option 2 - Door Open Time

*(Factory Default - 5 Seconds)*

This is the length of time for which the door is allowed to stay open BEFORE any warnings or alarms occur<sup>1</sup>.

See Table 5 for various settings.

### 3. Timer Option 3 - Door Open Pre-Warn Time

*(Factory Default - 0 Seconds)*

This is the length of time for which a warning will be issued BEFORE the Door Open Alarm is activated<sup>1</sup>.

See Table 5 for various settings.

### 4. Timer Option 4 - Door Open Alarm

*(Factory Default - 30 Seconds)*

This is the length of time for which the Door Open Alarm will be active<sup>1</sup>.

See Table 5 for various settings.

<sup>1</sup>After a valid Tag is presented and the door is opened, the Door Open Timer begins to count down. If the door remains open after the Door Open Time has expired, the buzzer will begin to sound a warning tone for the duration of the Door Open Pre-Warn Time. If the door still remains open after the Door Open Pre-Warn Time has expired, the Door Open Alarm will activate. The alarm condition will remain activated for the duration of the Door Open Alarm Time or reset if the door is closed.

---

## 5. Timer Option 5 - Door Forced Alarm

*(Factory Default - Latched)*

The Door Forced Alarm time controls the length of time for which the Door Forced Alarm activates.

See Table 5 below for various settings.

## 6. Timer Option 6 - Hold Off Time

*(Factory Default - 0 Seconds)*

The Hold Off time is only used when door status monitoring is required in conjunction with a pre-impulse strike lock.

The Hold Off time is the time during which the door can be opened without triggering a door forced alarm.

Should the door be opened after the Hold off time expires then a door forced alarm will be generated.

Due to the characteristics of pre-impulse strikers this allows for a measure of security to be maintained.

TIMER VALUE SETTINGS				
Timer	Timer Range 1 second increments	Effect of 0	Effect of 1-254	Effect of 255
Relay	0 - 255	No relay action	Pulse duration	Latched
Door Open	0 - 255	Instantaneous progression to door open pre-warn	Length of door open time	Continuous door open no progression to door open pre-warn
Door Open Pre-Warn	0 - 255	Instantaneous progression to door open alarm	Length of pre-warn time	Continuous pre-warn no progression to door open alarm
Door Open Alarm	0 - 255	No alarm	Pulse duration	Continuous alarm/ latched
Door Forced Alarm	0 - 255	No alarm	Pulse duration	Continuous alarm/ latched
Hold Off Time	0 - 255	No hold off	Hold off duration	Hold off duration

*Table 5. Timer Value Settings*

# EXAMPLE

## How to use the LED's to set the various Timers

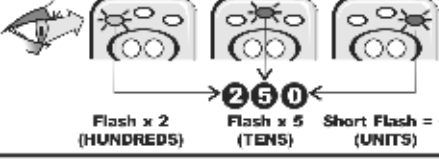
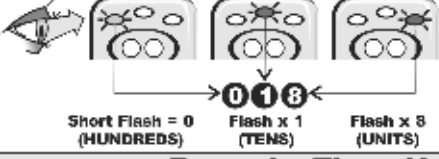
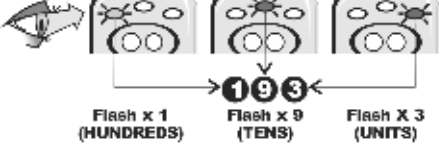
	Graphical Instructions	Written Instructions
<b>Example: Timer Value set to 5 Seconds</b>		
1	 <p>Short Flash = 0 (HUNDREDS)    Short Flash = 0 (TENS)    Flash x5 (UNITS)</p>	<p><b>TOP ORANGE LIGHT</b> will <b>SHORT FLASH</b> to indicate <b>0 HUNDREDS</b></p> <p><b>TOP GREEN LIGHT</b> will <b>SHORT FLASH</b> to indicate <b>0 TENS</b></p> <p><b>TOP RED LIGHT</b> will <b>FLASH 5 TIMES</b> to indicate <b>5 UNITS</b></p>
<b>Example: Timer Value set to 50 Seconds</b>		
2	 <p>Short Flash = 0 (HUNDREDS)    Flash x 5 (TENS)    Short Flash = 0 (UNITS)</p>	<p><b>TOP ORANGE LIGHT</b> will <b>SHORT FLASH</b> to indicate <b>0 HUNDREDS</b></p> <p><b>TOP GREEN LIGHT</b> will <b>FLASH 5 TIMES</b> to indicate <b>5 TENS</b></p> <p><b>TOP RED LIGHT</b> will <b>SHORT FLASH</b> to indicate <b>0 UNITS</b></p>
<b>Example: Timer Value set to 250 Seconds</b>		
3	 <p>Flash x 2 (HUNDREDS)    Flash x 5 (TENS)    Short Flash = 0 (UNITS)</p>	<p><b>TOP ORANGE LIGHT</b> will <b>FLASH 2 TIMES</b> to indicate <b>2 HUNDREDS</b></p> <p><b>TOP GREEN LIGHT</b> will <b>FLASH 5 TIMES</b> to indicate <b>5 TENS</b></p> <p><b>TOP RED LIGHT</b> will <b>SHORT FLASH</b> to indicate <b>0 UNITS</b></p>
<b>Example: Timer Value set to 18 Seconds</b>		
4	 <p>Short Flash = 0 (HUNDREDS)    Flash x 1 (TENS)    Flash x 8 (UNITS)</p>	<p><b>TOP ORANGE LIGHT</b> will <b>SHORT FLASH</b> to indicate <b>0 HUNDREDS</b></p> <p><b>TOP GREEN LIGHT</b> will <b>FLASH 1 TIME</b> to indicate <b>1 TEN</b></p> <p><b>TOP RED LIGHT</b> will <b>FLASH 8 TIMES</b> to indicate <b>8 UNITS</b></p>
<b>Example: Timer Value set to 193 Seconds</b>		
5	 <p>Flash x 1 (HUNDREDS)    Flash x 9 (TENS)    Flash X 3 (UNITS)</p>	<p><b>TOP ORANGE LIGHT</b> will <b>FLASH 1 TIME</b> to indicate <b>1 HUNDRED</b></p> <p><b>TOP GREEN LIGHT</b> will <b>FLASH 9 TIMES</b> to indicate <b>9 TENS</b></p> <p><b>TOP RED LIGHT</b> will <b>FLASH 3 TIMES</b> to indicate <b>3 UNITS</b></p>



# Change Relay Time

## Please Note:

- Time selectable in 1 second increments from 1 to 255 seconds.
- For LATCHING RELAY select 255
- **To ABORT wait for ± 60 seconds for the SOLO to RESET**

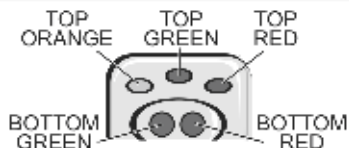

Present & Hold Master Tag

































Remove Master Tag

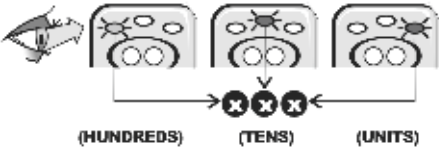

Present & Remove Master Tag

Graphical Instructions		Written Instructions	
1	Observe Lights		<b>Present and HOLD</b> either Master Tag until all lights turn ON
2			<b>Remove</b> the Master Tag
3	Observe Top Lights		<b>Top green light</b> will remain on
4	Observe Bottom Lights		Only <b>BOTTOM RED LIGHT ON</b> <b>Present and remove</b> the Master Tag
5			<b>Top red light</b> will turn on
6			Only <b>BOTTOM RED LIGHT ON</b> <b>Present and remove</b> the Master Tag
7			<b>Top orange light</b> will turn on
8			Only <b>BOTTOM RED LIGHT ON</b> <b>Present and remove</b> the Master Tag
9			<b>Top orange</b> and <b>top red light</b> will turn on
10			Only <b>BOTTOM GREEN LIGHT ON</b> <b>Present and remove</b> the Master Tag

11			<b>Top red light</b> will turn on
12	 		Only <b>BOTTOM GREEN LIGHT ON</b> <b>Present and remove</b> the Master Tag
13*	    Hundreds                  Tens                  Units		<b>TOP ORANGE LIGHT</b> will <b>FLASH</b> to indicate <b>HUNDREDS</b> <b>TOP GREEN LIGHT</b> will <b>FLASH</b> to indicate <b>TENS</b> <b>TOP RED LIGHT</b> will <b>FLASH</b> to indicate <b>UNITS</b> of <b>CURRENT</b> Relay Time
14	 		Only <b>BOTTOM RED LIGHT ON</b> <b>Present and HOLD</b> the Master Tag
15	   Units Short Flash=0		On <b>TOP RED LIGHT</b> count number of flashes required for <b>UNITS</b> value. <b>Short Flash=0</b>
16			Remove Master Tag when required <b>UNITS</b> value reached
17			Only the <b>TOP RED LIGHT</b> will remain <b>ON</b>
18			<b>Present and HOLD</b> Master Tag
19	   Tens Short Flash=0		On <b>TOP GREEN LIGHT</b> count number of flashes required for <b>TENS</b> value. <b>Short Flash=0</b>
20			Remove Master Tag when required <b>TENS</b> value reached.
21			The <b>TOP GREEN LIGHT</b> and <b>TOP RED LIGHT</b> will remain <b>ON</b>
22			<b>Present and HOLD</b> Master Tag
23	   Hundreds Short Flash=0		On <b>TOP ORANGE LIGHT</b> count number of flashes required for <b>HUNDREDS</b> value. <b>Short Flash=0</b>
24			Remove Master Tag when required <b>HUNDREDS</b> reached.

25*	 <p>(HUNDREDS)      (TENS)      (UNITS)</p>	<p>Confirm time you have selected is correct.</p> <p><b>TOP ORANGE LIGHT</b> indicates <b>HUNDREDS</b>  <b>TOP GREEN LIGHT</b> indicates <b>TENS</b>  <b>TOP RED LIGHT</b> indicates <b>UNITS</b></p>
26	<p><b>To ACCEPT NEW TIME</b></p>   <p>Only <b>BOTTOM GREEN LIGHT ON</b>  <b>Present and remove</b> the Master Tag</p>	<p><b>To CHANGE VALUE</b></p> <p><b>Repeat from step 14 above</b></p>
27	 	<p>Both <b>BOTTOM GREEN LIGHT ON</b> and  <b>BOTTOM RED LIGHT ON</b>  <b>Present and remove</b> the Master Tag</p>
28	 	<p>Both <b>BOTTOM GREEN LIGHT ON</b> and  <b>BOTTOM RED LIGHT ON</b>  <b>Present and remove</b> the Master Tag</p>
<p>The <b>SOLO</b> Reader will enter normal RUN MODE</p>		
<p>It is recommended that the attached Memory Location allocation and Parameter settings form be updated.</p>		
<p>* Examples for setting timer values may be found on page 64</p>		

# Change Door Open Time

**Please Note:**

- Time selectable in 1 second increments from 1 to 255 seconds.
- For INFINITE DOOR OPEN TIME select 255
- **To ABORT wait for ± 60 seconds for the SOLO to RESET**

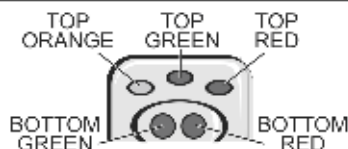

Present & Hold Master Tag















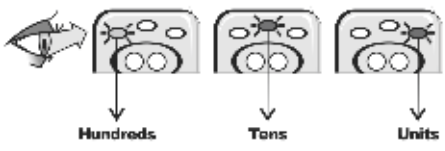







Remove Master Tag

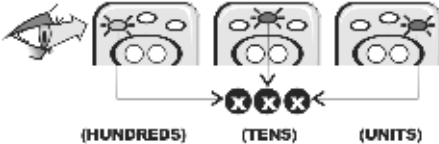

Present & Remove Master Tag

Graphical Instructions		Written Instructions	
1	Observe Lights		<b>Present and HOLD</b> either Master Tag until all lights turn ON
2			<b>Remove</b> the Master Tag
3	Observe Top Lights		<b>Top green light</b> will remain on
4	Observe Bottom Lights		Only <b>BOTTOM RED LIGHT ON</b> <b>Present and remove</b> the Master Tag
5			<b>Top red light</b> will turn on
6			Only <b>BOTTOM RED LIGHT ON</b> <b>Present and remove</b> the Master Tag
7			<b>Top orange light</b> will turn on
8			Only <b>BOTTOM RED LIGHT ON</b> <b>Present and remove</b> the Master Tag
9			<b>Top orange and top red light</b> will turn on
10			Only <b>BOTTOM GREEN LIGHT ON</b> <b>Present and remove</b> the Master Tag

11			<b>Top red light</b> will turn on
12			Only <b>BOTTOM RED LIGHT ON</b> <b>Present and remove</b> the Master Tag
13			<b>Top green light</b> will turn on
14			Only <b>BOTTOM GREEN LIGHT ON</b> <b>Present and remove</b> the Master Tag
15*			<b>TOP ORANGE LIGHT</b> will <b>FLASH</b> to indicate <b>HUNDREDS</b> <b>TOP GREEN LIGHT</b> will <b>FLASH</b> to indicate <b>TENS</b> <b>TOP RED LIGHT</b> will <b>FLASH</b> to indicate <b>UNITS</b> of <b>CURRENT</b> Relay Time
16			Only <b>BOTTOM RED LIGHT ON</b> <b>Present and HOLD</b> the Master Tag
17			On <b>TOP RED LIGHT</b> count number of flashes required for <b>UNITS</b> value. <b>Short Flash=0</b>
18			Remove Master Tag when required <b>UNITS</b> value reached
19			Only the <b>TOP RED LIGHT</b> will remain <b>ON</b>
20			<b>Present and HOLD</b> Master Tag
21			On <b>TOP GREEN LIGHT</b> count number of flashes required for <b>TENS</b> value. <b>Short Flash=0</b>
22			Remove Master Tag when required <b>TENS</b> value reached.
23			The <b>TOP GREEN LIGHT</b> and <b>TOP RED LIGHT</b> will remain <b>ON</b>
24			<b>Present and HOLD</b> Master Tag

25		<p>On <b>TOP ORANGE LIGHT</b> count number of flashes required for <b>HUNDREDS</b> value.  <b>Short Flash=0</b></p>
26		<p>Remove Master Tag when required <b>HUNDREDS</b> reached.</p>
27*		<p>Confirm time you have selected is correct.</p> <p><b>TOP ORANGE LIGHT</b> indicates <b>HUNDREDS</b>  <b>TOP GREEN LIGHT</b> indicates <b>TENS</b>  <b>TOP RED LIGHT</b> indicates <b>UNITS</b></p>
28	<p style="text-align: center;"><b>To ACCEPT NEW TIME</b></p>  <p>Only <b>BOTTOM GREEN LIGHT ON</b>  <b>Present and remove</b> the Master Tag</p>	<p style="text-align: center;"><b>To CHANGE VALUE</b></p> <p style="text-align: center;"><b>Repeat from step 16 above</b></p>
29		<p>Both <b>BOTTOM GREEN LIGHT ON</b> and <b>BOTTOM RED LIGHT ON</b>  <b>Present and remove</b> the Master Tag</p>
30		<p>Both <b>BOTTOM GREEN LIGHT ON</b> and <b>BOTTOM RED LIGHT ON</b>  <b>Present and remove</b> the Master Tag</p>
<p>The <b>SOLO</b> Reader will enter normal RUN MODE</p>		
<p>It is recommended that the attached Memory Location allocation and Parameter settings form be updated.</p>		
<p>* Examples for setting timer values may be found on page 64</p>		

















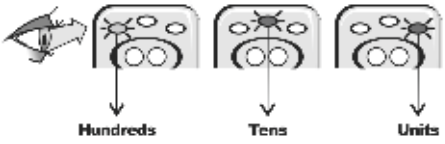

# Change Door Open Pre-Warn Time

**Please Note:**









- Time selectable in 1 second increments from 1 to 255 seconds.
- For INFINITE DOOR OPEN PRE-WARN TIME select 255
- **To ABORT wait for ± 60 seconds for the SOLO to RESET**

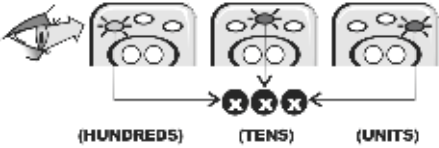

Graphical Instructions		Written Instructions
1	Observe Lights	<b>Present and HOLD</b> either Master Tag until <b>all lights turn ON</b>
2		<b>Remove</b> the Master Tag
3	Observe Top Lights	<b>Top green light</b> will remain on
4	Observe Bottom Lights	Only <b>BOTTOM RED LIGHT ON</b> <b>Present and remove</b> the Master Tag
5		<b>Top red light</b> will turn on
6		Only <b>BOTTOM RED LIGHT ON</b> <b>Present and remove</b> the Master Tag
7		<b>Top orange light</b> will turn on
8		Only <b>BOTTOM RED LIGHT ON</b> <b>Present and remove</b> the Master Tag
9		<b>Top orange</b> and <b>top red light</b> will turn on
10		Only <b>BOTTOM GREEN LIGHT ON</b> <b>Present and remove</b> the Master Tag

11			<b>Top red light</b> will turn on
12	 		Only <b>BOTTOM RED LIGHT ON</b> <b>Present and remove</b> the Master Tag
13			<b>Top green light</b> will turn on
14	 		Only <b>BOTTOM RED LIGHT ON</b> <b>Present and remove</b> the Master Tag
15			<b>Top green</b> and <b>Top red light</b> will turn on
16	 		Only <b>BOTTOM GREEN LIGHT ON</b> <b>Present and remove</b> the Master Tag
17 <sup>‡</sup>			<b>TOP ORANGE LIGHT</b> will <b>FLASH</b> to indicate <b>HUNDREDS</b> <b>TOP GREEN LIGHT</b> will <b>FLASH</b> to indicate <b>TENS</b> <b>TOP RED LIGHT</b> will <b>FLASH</b> to indicate <b>UNITS</b> of <b>CURRENT</b> Door Open Pre-Warn Time
18	 		Only <b>BOTTOM RED LIGHT ON</b> <b>Present and HOLD</b> the Master Tag
19	 	Units Short Flash=0	On <b>TOP RED LIGHT</b> count number of flashes required for <b>UNITS</b> value. <b>Short Flash=0</b>
20			Remove Master Tag when required <b>UNITS</b> value reached
21			Only the <b>TOP RED LIGHT</b> will remain <b>ON</b>
22			<b>Present and HOLD</b> Master Tag
23	 	Tens Short Flash=0	On <b>TOP GREEN LIGHT</b> count number of flashes required for <b>TENS</b> value. <b>Short Flash=0</b>
24			Remove Master Tag when required <b>TENS</b> value reached.



25		<p>The <b>TOP GREEN LIGHT</b> and <b>TOP RED LIGHT</b> will remain <b>ON</b></p>
26		<p><b>Present and HOLD</b> Master Tag</p>
27		<p>On <b>TOP ORANGE LIGHT</b> count number of flashes required for <b>HUNDREDS</b> value. <b>Short Flash=0</b></p>
28		<p>Remove Master Tag when required <b>HUNDREDS</b> reached.</p>
29		<p>Confirm time you have selected is correct.</p> <p><b>TOP ORANGE LIGHT</b> indicates <b>HUNDREDS</b>  <b>TOP GREEN LIGHT</b> indicates <b>TENS</b>  <b>TOP RED LIGHT</b> indicates <b>UNITS</b></p>
<p><b>To ACCEPT NEW TIME</b></p>		<p><b>To CHANGE VALUE</b></p>
30		<p><b>Repeat from step 18 above</b></p>
<p>Only <b>BOTTOM GREEN LIGHT ON</b> <b>Present and remove</b> the Master Tag</p>		
31		<p>Both <b>BOTTOM GREEN LIGHT ON</b> and <b>BOTTOM RED LIGHT ON</b> <b>Present and remove</b> the Master Tag</p>
32		<p>Both <b>BOTTOM GREEN LIGHT ON</b> and <b>BOTTOM RED LIGHT ON</b> <b>Present and remove</b> the Master Tag</p>
<p>The <b>SOLO</b> Reader will enter normal RUN MODE</p>		
<p>It is recommended that the attached Memory Location allocation and Parameter settings form be updated.</p>		
<p>* Examples for setting timer values may be found on page 64</p>		





















# Change Door Open Alarm Time

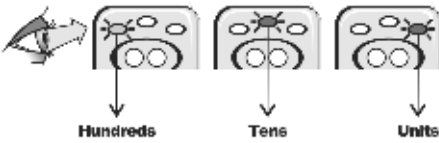











**Please Note:**

- Time selectable in 1 second increments from 1 to 255 seconds.
- For LATCHED DOOR OPEN ALARM select 255
- **To ABORT wait for ± 60 seconds for the SOLO to RESET**

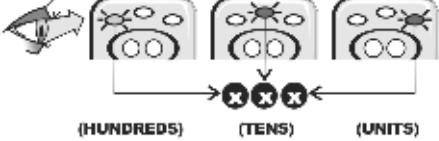

Graphical Instructions		Written Instructions	
1	Observe Lights		<b>Present and HOLD</b> either Master Tag until <b>all lights turn ON</b>
2			<b>Remove</b> the Master Tag
3	Observe Top Lights		<b>Top green light</b> will remain on
4	Observe Bottom Lights		Only <b>BOTTOM RED LIGHT ON</b> <b>Present and remove</b> the Master Tag
5			<b>Top red light</b> will turn on
6			Only <b>BOTTOM RED LIGHT ON</b> <b>Present and remove</b> the Master Tag
7			<b>Top orange light</b> will turn on
8			Only <b>BOTTOM RED LIGHT ON</b> <b>Present and remove</b> the Master Tag
9			<b>Top orange</b> and <b>top red light</b> will turn on
10			Only <b>BOTTOM GREEN LIGHT ON</b> <b>Present and remove</b> the Master Tag

11			<b>Top red light</b> will turn on
12	 		Only <b>BOTTOM RED LIGHT ON</b> <b>Present and remove</b> the Master Tag
13			<b>Top green light</b> will turn on
14	 		Only <b>BOTTOM RED LIGHT ON</b> <b>Present and remove</b> the Master Tag
15			<b>Top green</b> and <b>Top red light</b> will turn on
16	 		Only <b>BOTTOM RED LIGHT ON</b> <b>Present and remove</b> the Master Tag
17			<b>Top orange light</b> will turn on
18	 		Only <b>BOTTOM GREEN LIGHT ON</b> <b>Present and remove</b> the Master Tag
19			<b>TOP ORANGE LIGHT</b> will <b>FLASH</b> to indicate <b>HUNDREDS</b> <b>TOP GREEN LIGHT</b> will <b>FLASH</b> to indicate <b>TENS</b> <b>TOP RED LIGHT</b> will <b>FLASH</b> to indicate <b>UNITS</b> of <b>CURRENT</b> Door Open Alarm Time
20	 		Only <b>BOTTOM RED LIGHT ON</b> <b>Present and HOLD</b> the Master Tag
21	 		On <b>TOP RED LIGHT</b> count number of flashes required for <b>UNITS</b> value. <b>Short Flash=0</b>
22			Remove Master Tag when required <b>UNITS</b> value reached
23			Only the <b>TOP RED LIGHT</b> will remain <b>ON</b>
24			<b>Present and HOLD</b> Master Tag

25		<p>On <b>TOP GREEN LIGHT</b> count number of flashes required for <b>TENS</b> value.  <b>Short Flash=0</b></p>
26		<p>Remove Master Tag when required <b>TENS</b> value reached.</p>
27		<p>The <b>TOP GREEN LIGHT</b> and <b>TOP RED LIGHT</b> will remain <b>ON</b></p>
28		<p><b>Present and HOLD</b> Master Tag</p>
29		<p>On <b>TOP ORANGE LIGHT</b> count number of flashes required for <b>HUNDREDS</b> value.  <b>Short Flash=0</b></p>
30		<p>Remove Master Tag when required <b>HUNDREDS</b> reached.</p>
31*		<p>Confirm time you have selected is correct.</p> <p><b>TOP ORANGE LIGHT</b> indicates <b>HUNDREDS</b>  <b>TOP GREEN LIGHT</b> indicates <b>TENS</b>  <b>TOP RED LIGHT</b> indicates <b>UNITS</b></p>
32	<p style="text-align: center;"><b>To ACCEPT NEW TIME</b></p>  <p>Only <b>BOTTOM GREEN LIGHT ON</b>  <b>Present and remove</b> the Master Tag</p>	<p style="text-align: center;"><b>To CHANGE VALUE</b></p> <p style="text-align: center;"><b>Repeat from step 20 above</b></p>
33	 	<p>Both <b>BOTTOM GREEN LIGHT ON</b> and <b>BOTTOM RED LIGHT ON</b>  <b>Present and remove</b> the Master Tag</p>
34	 	<p>Both <b>BOTTOM GREEN LIGHT ON</b> and <b>BOTTOM RED LIGHT ON</b>  <b>Present and remove</b> the Master Tag</p>
<p>The <b>SOLO</b> Reader will enter normal RUN MODE</p>		
<p>It is recommended that the attached Memory Location allocation and Parameter settings form be updated.</p>		
<p>* Examples for setting Timer Values may be found on page 64</p>		















# Change Door Forced Alarm Time





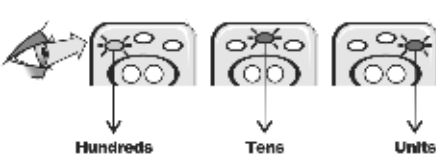





**Please Note:**



- Time selectable in 1 second increments from 1 to 255 seconds.
- For LATCHED DOOR FORCED ALARM select 255

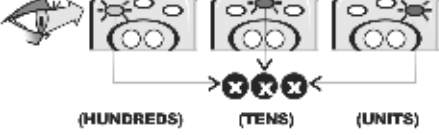

Graphical Instructions		Written Instructions	
1	Observe Lights		<b>Present and HOLD</b> either Master Tag until <b>all lights turn ON</b>
2			<b>Remove</b> the Master Tag
3	Observe Top Lights		<b>Top green light</b> will remain on
4	Observe Bottom Lights		Only <b>BOTTOM RED LIGHT ON</b> <b>Present and remove</b> the Master Tag
5			<b>Top red light</b> will turn on
6			Only <b>BOTTOM RED LIGHT ON</b> <b>Present and remove</b> the Master Tag
7			<b>Top orange light</b> will turn on
8			Only <b>BOTTOM RED LIGHT ON</b> <b>Present and remove</b> the Master Tag
9			<b>Top orange</b> and <b>top red light</b> will turn on
10			Only <b>BOTTOM GREEN LIGHT ON</b> <b>Present and remove</b> the Master Tag

11		<b>Top red light</b> will turn on
12		Only <b>BOTTOM RED LIGHT ON</b> <b>Present and remove</b> the Master Tag
13		<b>Top green light</b> will turn on
14		Only <b>BOTTOM RED LIGHT ON</b> <b>Present and remove</b> the Master Tag
15		<b>Top green</b> and <b>Top red light</b> will turn on
16		Only <b>BOTTOM RED LIGHT ON</b> <b>Present and remove</b> the Master Tag
17		<b>Top orange light</b> will turn on
18		Only <b>BOTTOM RED LIGHT ON</b> <b>Present and remove</b> the Master Tag
19		<b>Top orange</b> and <b>top red light</b> will turn on
20		Only <b>BOTTOM GREEN LIGHT ON</b> <b>Present and remove</b> the Master Tag
21*		<b>TOP ORANGE LIGHT</b> will <b>FLASH</b> to indicate <b>HUNDREDS</b> <b>TOP GREEN LIGHT</b> will <b>FLASH</b> to indicate <b>TENS</b> <b>TOP RED LIGHT</b> will <b>FLASH</b> to indicate <b>UNITS</b> of <b>CURRENT</b> Door Forced Alarm Time
22		Only <b>BOTTOM RED LIGHT ON</b> <b>Present and HOLD</b> the Master Tag
23		On <b>TOP RED LIGHT</b> count number of flashes required for <b>UNITS</b> value. <b>Short Flash=0</b>
24		Remove Master Tag when required <b>UNITS</b> value reached

25		Only the <b>TOP RED LIGHT</b> will remain <b>ON</b>
26		<b>Present and HOLD</b> Master Tag
27		On <b>TOP GREEN LIGHT</b> count number of flashes required for <b>TENS</b> value. <b>Short Flash=0</b>
28		Remove Master Tag when required <b>TENS</b> value reached.
29		The <b>TOP GREEN LIGHT</b> and <b>TOP RED LIGHT</b> will remain <b>ON</b>
30		<b>Present and HOLD</b> Master Tag
31		On <b>TOP ORANGE LIGHT</b> count number of flashes required for <b>HUNDREDS</b> value. <b>Short Flash=0</b>
32		Remove Master Tag when required <b>HUNDREDS</b> reached.
33*		Confirm time you have selected is correct.  <b>TOP ORANGE LIGHT</b> indicates <b>HUNDREDS</b> <b>TOP GREEN LIGHT</b> indicates <b>TENS</b> <b>TOP RED LIGHT</b> indicates <b>UNITS</b>
34	<p data-bbox="176 1055 505 1078"><b>To ACCEPT NEW TIME</b></p>  	<p data-bbox="680 1055 960 1078"><b>To CHANGE VALUE</b></p> <p data-bbox="664 1141 977 1165">Repeat from step 22 above</p>
	Only <b>BOTTOM GREEN LIGHT ON</b> <b>Present and remove</b> the Master Tag	

35		Both <b>BOTTOM GREEN LIGHT ON</b> and <b>BOTTOM RED LIGHT ON</b> <b>Present and remove</b> the Master Tag
36		Both <b>BOTTOM GREEN LIGHT ON</b> and <b>BOTTOM RED LIGHT ON</b> <b>Present and remove</b> the Master Tag
The SOLO Reader will enter normal RUN MODE		
It is recommended that the attached Memory Location allocation and Parameter settings form be updated.		
* Examples for setting timer values may be found on page 64		



# Change Hold Off Time











**Please Note:**

- Time selectable in 1 second increments from 1 to 255 seconds.



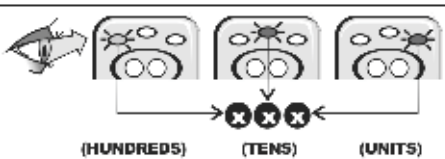

Graphical Instructions		Written Instructions
1	Observe Lights	<b>Present and HOLD</b> either Master Tag until <b>all lights turn ON</b>
2		<b>Remove</b> the Master Tag
3	Observe Top Lights	<b>Top green light</b> will remain on
4	Observe Bottom Lights	Only <b>BOTTOM RED LIGHT ON</b> <b>Present and remove</b> the Master Tag
5		<b>Top red light</b> will turn on
6		Only <b>BOTTOM RED LIGHT ON</b> <b>Present and remove</b> the Master Tag
7		<b>Top orange light</b> will turn on
8		Only <b>BOTTOM RED LIGHT ON</b> <b>Present and remove</b> the Master Tag
9		<b>Top orange</b> and <b>top red light</b> will turn on
10		Only <b>BOTTOM GREEN LIGHT ON</b> <b>Present and remove</b> the Master Tag

11			<b>Top red light</b> will turn on
12			Only <b>BOTTOM RED LIGHT ON</b> <b>Present and remove</b> the Master Tag
13			<b>Top green light</b> will turn on
14			Only <b>BOTTOM RED LIGHT ON</b> <b>Present and remove</b> the Master Tag
15			<b>Top green</b> and <b>Top red light</b> will turn on
16			Only <b>BOTTOM RED LIGHT ON</b> <b>Present and remove</b> the Master Tag
17			<b>Top orange light</b> will turn on
18			Only <b>BOTTOM RED LIGHT ON</b> <b>Present and remove</b> the Master Tag
19			<b>Top orange</b> and <b>top red light</b> will turn on
20			Only <b>BOTTOM RED LIGHT ON</b> <b>Present and remove</b> the Master Tag
21			<b>Top orange light</b> and <b>top green light</b> will turn on
22			Only <b>BOTTOM GREEN LIGHT ON</b> <b>Present and remove</b> the Master Tag
23 <sup>+</sup>			<b>TOP ORANGE LIGHT</b> will <b>FLASH</b> to indicate <b>HUNDREDS</b> <b>TOP GREEN LIGHT</b> will <b>FLASH</b> to indicate <b>TENS</b> <b>TOP RED LIGHT</b> will <b>FLASH</b> to indicate <b>UNITS</b> of <b>CURRENT</b> Door Forced Alarm Time
24			Only <b>BOTTOM RED LIGHT ON</b> <b>Present and HOLD</b> the Master Tag

25		On <b>TOP RED LIGHT</b> count number of flashes required for <b>UNITS</b> value. <b>Short Flash=0</b>
26		Remove Master Tag when required <b>UNITS</b> value reached
27		Only the <b>TOP RED LIGHT</b> will remain <b>ON</b>
28		<b>Present and HOLD</b> Master Tag
29		On <b>TOP GREEN LIGHT</b> count number of flashes required for <b>TENS</b> value. <b>Short Flash=0</b>
30		Remove Master Tag when required <b>TENS</b> value reached.
31		The <b>TOP GREEN LIGHT</b> and <b>TOP RED LIGHT</b> will remain <b>ON</b>
32		<b>Present and HOLD</b> Master Tag
33		On <b>TOP ORANGE LIGHT</b> count number of flashes required for <b>HUNDREDS</b> value. <b>Short Flash=0</b>
34		Remove Master Tag when required <b>HUNDREDS</b> reached.
35*		Confirm time you have selected is correct. <b>TOP ORANGE LIGHT</b> indicates <b>HUNDREDS</b> <b>TOP GREEN LIGHT</b> indicates <b>TENS</b> <b>TOP RED LIGHT</b> indicates <b>UNITS</b>

<b>To ACCEPT NEW TIME</b>	
36	
Only <b>BOTTOM GREEN LIGHT ON</b> <b>Present and remove</b> the Master Tag	

<b>To CHANGE VALUE</b>	
Repeat from step 24 above	

37		Both <b>BOTTOM GREEN LIGHT ON</b> and <b>BOTTOM RED LIGHT ON</b> <b>Present and remove</b> the Master Tag
38		Both <b>BOTTOM GREEN LIGHT ON</b> and <b>BOTTOM RED LIGHT ON</b> <b>Present and remove</b> the Master Tag
The <b>SOLO</b> Reader will enter normal RUN MODE		
It is recommended that the attached Memory Location allocation and Parameter settings form be updated.		
* Examples for setting timer values may be found on page 64		

# Special Functions

## TURBO MODE

### Overview

The rate at which the system steps from one menu to the next while programming can be increased selecting TURBO MODE. This is recommended for the installers that are familiar with the system and would like to work more quickly through the programming process.











When exiting from programme mode the TURBO MORE rate is reset back to the standard rate.

## TURBO MODE

### Please Note:

- To **ABORT** wait for  $\pm 60$  seconds for the **SOLO** to **RESET**



Graphical Instructions		Written Instructions	
1	Observe Lights  		<b>Present and HOLD</b> either Master Tag until <b>all lights turn ON</b>
2	Observe Top Lights  		<b>Continue HOLDING</b> <b>Top red light will turn on</b>
3	 		<b>Continue HOLDING</b> <b>Top green light will turn on</b>
4	 		<b>Remove</b> the Master Tag
The <b>SOLO</b> Reader is in Turbo Mode. Continue with Programming as required.			

---

# AUTOLEARN

## Overview

Should it be necessary to learn user tags, which are in circulation but not available in the system, the unit can be programmed for AUTOLEARN. When an unlearned tag is presented to the Reader, it will be automatically learned into the next available memory location and simultaneously the associated door lock or gate motor etc. operated.

For example if the memory has been erased, AUTOLEARN is the simplest way of relearning all the tags in circulation without having to get the tags back from the users.

The AUTOLEARN function ensures that once a tag has been learned into the system it cannot be re-learned, however the access point will be activated with the presentation of the tag.

To check the memory location of any particular tag that has been learned into the system use the procedure explained on page 22 of this manual.

## There are two modes of AUTOLEARN

### 1. Limited Time:

The AUTOLEARN will only remain in operation for a limited period of time ( $\pm$  7 days) after which it will become automatically DISABLED.

### 2. Unlimited Time:

The AUTOLEARN function will remain in operation until disabled.

 **WARNING:** Please note that during Autolearn operation any Zap Tag presented to the Solo Reader will be learned into memory. It is possible therefore that while in this mode, an unauthorized user could gain access.

# Autolearn: LIMITED TIME ( $\pm 7$ days)

**Please Note:**

- **THIS PROCESS MUST BE COMPLETED IN FULL. DO NOT ABORT THIS PROCEDURE.**
- Both Master Tags must be present in the **SOLO** Reader Memory.



Graphical Instructions		Written Instructions	
1	Observe Lights		<b>Present and HOLD</b> either Master Tag until <b>all lights turn ON</b>
2	Observe Top Lights		Continue <b>HOLDING</b> <b>Top Red Light</b> will turn ON
3			Continue <b>HOLDING</b> <b>Top Green Light</b> will turn ON
4	Observe Bottom Lights		Continue <b>HOLDING</b> <b>Top Green Light</b> will remain ON <b>Bottom Green Light</b> will turn ON
5			<b>Remove</b> the Master Tag









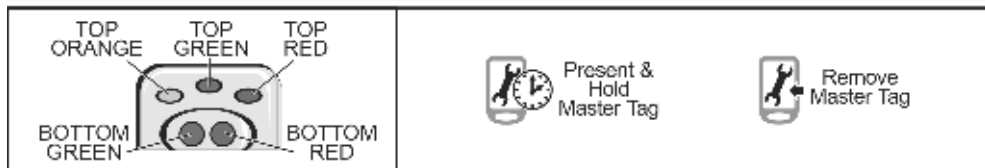

The BOTTOM GREEN LIGHT will flash to indicate that the **SOLO** Reader is in Autolearn Mode.

# Autolearn: UNLIMITED TIME

 **Please Note:**

- **THIS PROCESS MUST BE COMPLETED IN FULL. DO NOT ABORT THIS PROCEDURE.**
- Both Master Tags must be present in the **SOLO** Reader Memory.







Graphical Instructions		Written Instructions
1	Observe Lights  	<b>Present and HOLD</b> either Master Tag until <b>all lights turn ON</b>
2	Observe Top Lights  	Continue <b>HOLDING</b> <b>Top Red Light</b> will turn ON
3	 	Continue <b>HOLDING</b> <b>Top Green Light</b> will turn ON
3	Observe Bottom Lights  	Continue <b>HOLDING</b> <b>Top Green Light</b> will remain ON <b>Bottom Green Light</b> will turn ON
4	 	Continue <b>HOLDING</b> <b>Top Green Light</b> will remain ON <b>Bottom Green Light</b> will remain ON <b>Bottom Red Light</b> will turn ON
5		<b>Remove</b> the Master Tag

The **BOTTOM GREEN LIGHT** will flash to indicate that the **SOLO** Reader is in Autolearn Mode.



## Autolearn: DISABLE

Graphical Instructions		Written Instructions
1	Observe Lights   	<b>Present and HOLD</b> either Master Tag until <b>all TOP lights turn ON</b>
2		<b>Remove</b> the Master Tag
The <b>BOTTOM RED LIGHT</b> will flash to indicate that the <b>SOLO</b> Reader is now in Normal Run Mode		

# Memory Allocation & Parameter Settings Form

---

Memory Location	Relevant Information: Name, etc.
00	
01	
02	
03	
04	
05	
06	
07	
08	
09	
10	
11	
12	
13	
14	
15	
16	
17	
18	
19	
20	
21	
22	
23	
24	
25	
26	
27	
28	
29	
30	

<b>Memory Location</b>	<b>Relevant Information: Name, etc.</b>
31	
32	
33	
34	
35	
36	
37	
38	
39	
40	
41	
42	
43	
44	
45	
46	
47	
48	
49	
50	

<b>Configuration Label</b>	<b>Factory Defaults</b>	<b>User Settings</b>
Tag Buzzer	ON	
Free-Exit	ON	
External Door Forced Alarm	OFF	
Local Door Forced Alarm	OFF	
External Door Open Alarm	OFF	
Local Door Forced Alarm	OFF	
Smartswitch II	OFF	

<b>Timer Label</b>	<b>Factory Defaults</b>	<b>User Settings</b>
Relay Time	1	
Door Open Time	5	
Pre-Warn Time	0	
Door Open Alarm Time	30	
Door Forced Alarm Time	255 Latched	
Hold Off Time	0	



**Head Office: +27 11 699 2400**

**Technical Support: +27 11 699 2481**  
from 07h00 to 18h00 (GMT+2)



0.07.B.0028

**[www.centsys.com.au](http://www.centsys.com.au)**